

Product Specification

	Model: GDTQ35SP7G2R0	Rev. No.	Issued Date.	Page.
		A	2010, APR.30	1 / 22





Thin-Film-Transistor LCD Module
Model: GDTQ35SP7G2R0

Acceptance

Solomon Goldentek Display Corp.

168, Fu Xiang Blvd, Di Yong Industrial Zone,
Gao Bu, Dong Guan, Guang Dong 523273, China
FAX: +86-769-8873-7947

Approved and Checked by

Approved by	Checked by		Made by
			

Product Specification

	Model: GDTQ35SP7G2R0	Rev. No.	Issued Date.	Page.
		A	2010, APR.30	3 / 22

Contents

1. General Description and Features	4
1.1 Features	4
1.2 Applications	4
1.3 LCD Module	4
2. Mechanical Information	5
3. Dimensional Outlines	6
4. Block Diagram	7
4.1 TFT-LCD Module with BLU & TSP	7
5. Input Terminal Pin Assignment	8
5.1 Pin Assignment (LCD)	8
6. Optical Characteristics	10
7. Touch Screen Panel Specifications	13
7.1 Touch Panel	13
8. Absolute Maximum Ratings	13
8.1 Absolute Ratings of Environment	14
8.2 Electrical Absolute Rating	14
9. Electrical Characteristics	15
9.1 TFT-LCD Module (DC Characteristics)	15
9.2 Backlight Unit	15
10. Basic Display Color and Gray Scale	16
11. AC Timing	17
11.1 AC Characteristics (Pixel Timing)	17
11.2 SPI Timing Characteristics	18
11.3 Write SPI interface Timing Diagram	18
11.4 Read SPI interface Timing Diagram	19
11.5 AC Characteristics	20
11.6 Timing in Parallel RGB (24 bit SYNC Mode)	21
11.7 Timing in Parallel RGB (24 bit DE Mode)	21
12. Reliability Condition for LCD	22

Product Specification

	Model: GDTQ35SP7G2R0	Rev. No.	Issued Date.	Page.
		A	2010, APR.30	4 / 22

1. General Description and Features

GDTQ35SP7G2R0 is a TM (Transmissive) type color active matrix TFT (Thin Film Transistor) liquid crystal display (LCD) that uses amorphous silicon TFT as a switching device. This model is composed of a TFT-LCD module, a driver circuit, a back-light unit and a touch screen panel (TSP). The resolution of a 3.5" contains 320RGBx240 dots and can display up to 16.7M colors. The following table described the features of GDTQ35SP7G2R0.

1.1 Features

- Transmissive and back-light with six LEDs are available.
- TN (Twisted Nematic) mode.
- Programmable Frame & N-line polarity inversion.
- Using the Touch Screen Panel (Film to Glass type).
- System & Graphic interface 3-lines SPI + 8bits color RGB.
- DEN (Data Enable Input) mode, SYNC mode

1.2 Applications

- Display terminals for DSC (Digital Still Camera), PMP (Portable Multimedia Player) application products.

1.3 LCD Module

Item	Specification	Unit
Screen Size	3.5 inches	Diagonal
Display Resolution	320 x RGB x 240	Dot
Dot Pitch	0.219 (H) x 0.219 (V)	mm
Active Area	70.08 (H) x 52.56 (V)	mm
Outline Dimension	76.9 (W) x 63.9 (H) x 4.4 (D)	mm
Display Mode	Normally white/Transmissive	--
Pixel Arrangement	RGB-Stripe	--
Surface Treatment	Anti-glare (AG)	--
Display Color	16.7 M	--
Viewing Direction	6 o'clock	--
Input Interface	Digital 8-bits color RGB	--
Color Gamut	NTSC 60%	--

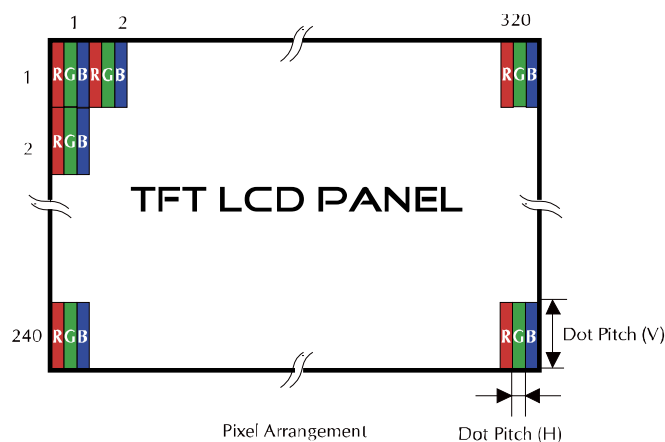

Product Specification

	Model: GDTQ35SP7G2R0	Rev. No.	Issued Date.	Page.
		A	2010, APR.30	5 / 22

2. Mechanical Information

Item		Min.	Typ.	Max.	Unit	Note
Module Size	Horizontal (H)	--	76.90	--	mm	--
	Vertical (V)	--	63.90	--	mm	(1)
	Thickness (T)	--	4.40	--	mm	(2)
Weight		--	TBD	--	g	--

Note (1) Not include FPC.

Refer to the Outline Dimension for further information.

(2) Back-light & touch screen unit are included.

Product Specification



Model: GDTQ35SP7G2R0

Rev. No.

Issued Date.

Page.

A

2010, APR.30

6 / 22

3. Dimensional Outlines

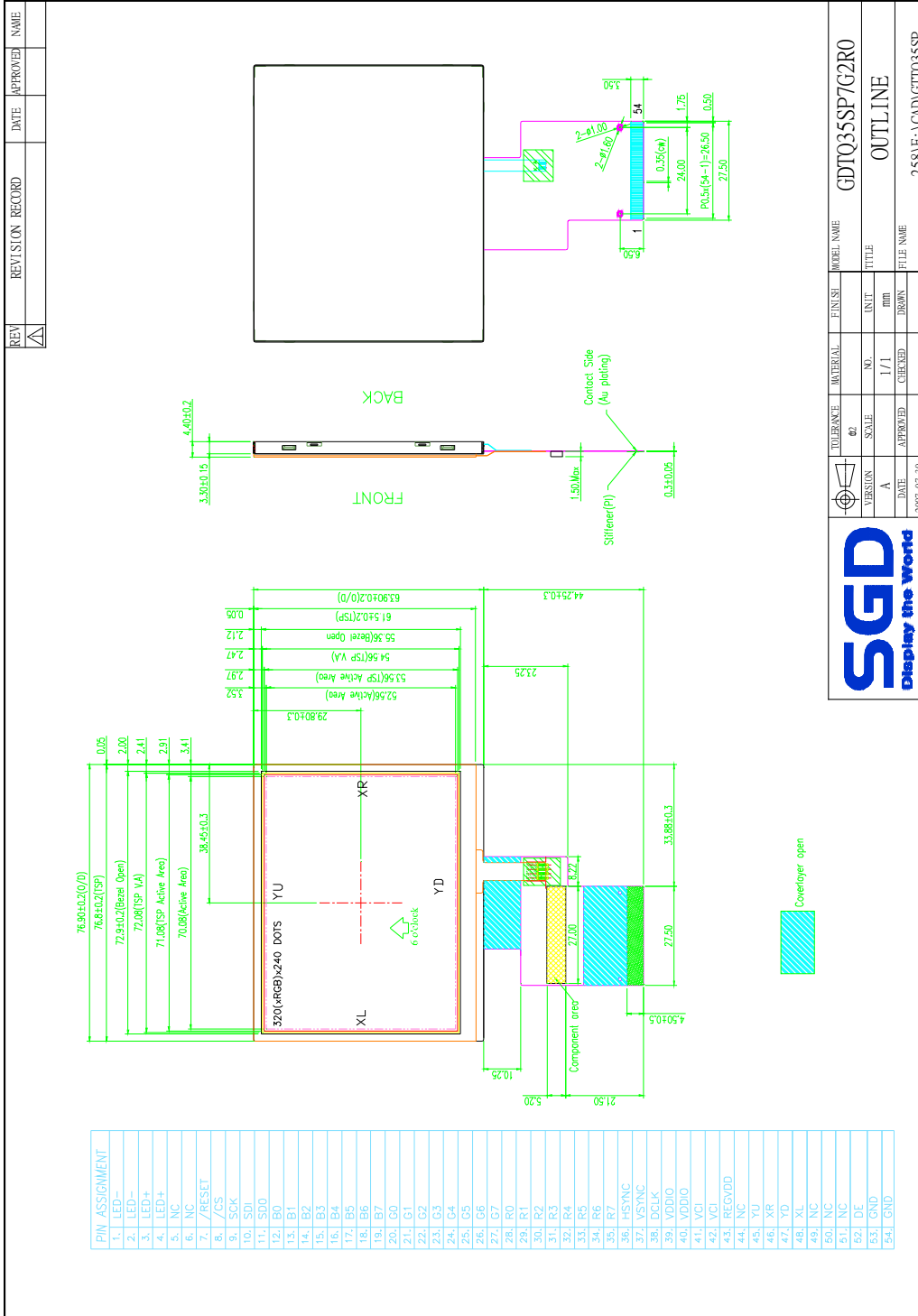

REV		REVISION RECORD		DATE	APPROVED NAME
TOLERANCE		Φ			
VERSION	A	SCALE			
DATE	2007.07.30	APPROVED			
MATERIAL		NO.	1/1	UNIT	
FINISH		CHECKED	DRAWN		mm
MODEL NAME		GDTQ35SP7G2R0			
TITLE		OUTLINE			
FILE NAME		258NAME: \CAD\GTTQ35SP			



Product Specification

	Model: GDTQ35SP7G2R0	Rev. No.	Issued Date.	Page.
		A	2010, APR.30	7 / 22

4. Block Diagram

4.1 TFT-LCD Module with BLU & TSP

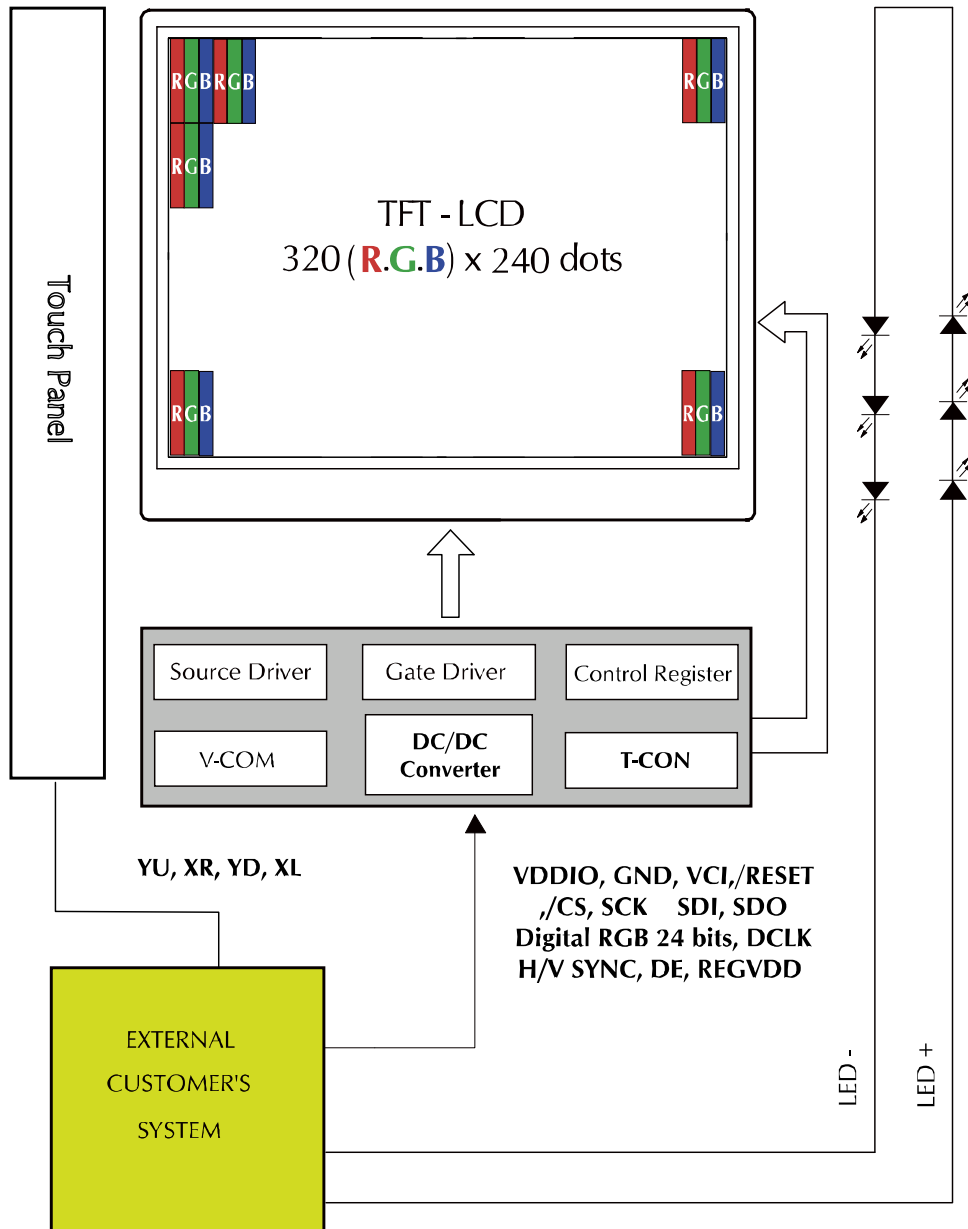

Product Specification



Model: GDTQ35SP7G2R0

Rev. No.

Issued Date.

Page.

A

2010, APR.30

8 / 22

5. Input Terminal Pin Assignment

5.1 Pin Assignment (LCD)

Pin No.	Symbol	I/O	Function	Remark
1	LED-	I	Backlight LED Ground	
2	LED-	I	Backlight LED Ground	
3	LED+	I	Backlight LED Power	
4	LED+	I	Backlight LED Power	
5	N/C	---	No Connection	
6	N/C	--	No Connection	
7	/RESET	I	Reset Signal	
8	/CS	I	SPI Interfaces, Chip Select pin	
9	SCLK	I	SPI Interface Clock pin	
10	SDI	I	SPI Interface Data INPUT pin	
11	SDO	O	SPI Interface Data OUTPUT pin	
12	B0	I	Blue Data Bit 0	
13	B1	I	Blue Data Bit 1	
14	B2	I	Blue Data Bit 2	
15	B3	I	Blue Data Bit 3	
16	B4	I	Blue Data Bit 4	
17	B5	I	Blue Data Bit 5	
18	B6	I	Blue Data Bit 6	
19	B7	I	Blue Data Bit 7	
20	G0	I	Green Data Bit0	
21	G1	I	Green Data Bit1	
22	G2	I	Green Data Bit2	
23	G3	I	Green Data Bit3	
24	G4	I	Green Data Bit4	
25	G5	I	Green Data Bit5	
26	G6	I	Green Data Bit6	
27	G7	I	Green Data Bit7	
28	R0	I	Red Data Bit0	
29	R1	I	Red Data Bit1	
30	R2	I	Red Data Bit2	
31	R3	I	Red Data Bit3	
32	R4	I	Red Data Bit4	
33	R5	I	Red Data Bit5	

Product Specification

	Model: GDTQ35SP7G2R0	Rev. No.	Issued Date.	Page.
		A	2010, APR.30	9 / 22

34	R6	I	Red Data Bit6	
35	R7	I	Red Data Bit7	
36	H _{SYNC}	I	Horizontal Sync Input	
37	V _{SYNC}	I	Vertical Sync Input	
38	D _{CLK}	I	Dot Clock	
39	V _{DDIO}	P	Voltage input pin for I/O logic. (2.5V to 3.6V)	
40	V _{DDIO}	P	Voltage input pin for I/O logic. (2.5V to 3.6V)	
41	V _{CI}	P	Booster input voltage pin. (2.5V to 3.6V)	
42	V _{CI}	P	Booster input voltage pin. (2.5V to 3.6V)	
43	REGVDD	I	Connect to voltage source between 2.5V to 3.6V	
44	N/C	--	No Connection	
45	YU	I	Touch Panel Top Side	
46	XR	I	Touch Panel Right Side	
47	YD	I	Touch Panel Bottom Side	
48	XL	I	Touch Panel Left Side	
49	N/C	--	No Connection	
50	N/C	--	No Connection	
51	N/C	--	No Connection	
52	DE	I	Data Enable Input	
53	GND	P	Ground	
54	GND	P	Ground	

Product Specification

	Model: GDTQ35SP7G2R0	Rev. No.	Issued Date.	Page.
		A	2010, APR.30	10 / 22

6. Optical Characteristics

The following items are measured under stable conditions. The optical characteristics should be measured in a dark room or equivalent state.

Measuring equipment: BM-7A

(Ta=25±2°C , VDDIO = V_{CI}=2.8V, I_f=40mA)

Item		Symbol	Condition	Min	Type	Max	Unit	Note
Brightness		--		200	250	--	cd/m ²	--
Response time		T _R	θ=0°	--	15	20	ms	Note.
		T _F		--	35	50	ms	
Contrast ratio		CR	At optimized viewing angle	240	300	--	--	Note.
Color Chromaticity (CIE1931)	Red	R _X	θ=0° Normal Viewing Angle	0.590	0.640	0.690	--	Note.
		R _Y		0.294	0.344	0.394		
	Green	G _X		0.248	0.298	0.348	--	
		G _Y		0.532	0.583	0.633		
	Blue	B _X		0.090	0.140	0.190	--	
		B _Y		0.080	0.130	0.180		
	White	W _X		0.262	0.312	0.362	--	
		W _Y		0.299	0.349	0.399		
Viewing Angle (6H)	Hor.	θ _R	CR≥10	50	60	--	Degree	Note.
		θ _L		50	60	--		
	Ver.	φ _H		40	50	--		
		φ _L		50	60	--		

Note : Definition of Transmittance (T%)

$$T = \text{Aperture Ratio (TFT)} \times W_Y \text{ (CF)}$$

Product Specification

	Model: GDTQ35SP7G2R0	Rev. No.	Issued Date.	Page.
		A	2010, APR.30	11 / 22

a. Test equipment setup

After stabilizing and leaving the panel alone shall be warmed up for the stable operation of LCM, the measurement should be executed. Measurement should be executed in a stable, windless, and dark room. Optical specifications are measured by Topcon BM-7(fast) with a viewing angle of 2° at a distance of 50cm and normal direction.

b. Definition of response time: Tr and Tf

The response time is defined as the following figure and shall be measured by switching the input signal for "black" and "white".

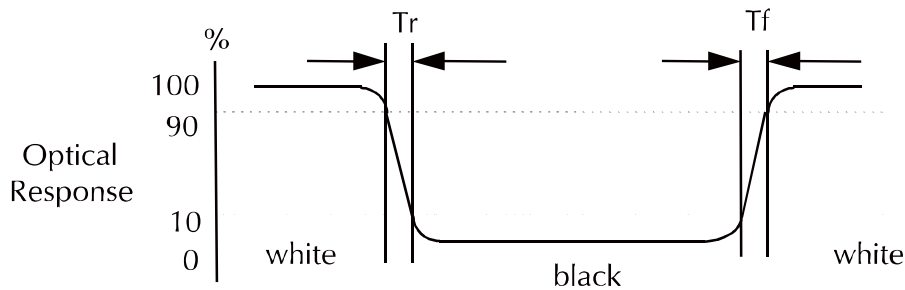

c. Definition of contrast ratio:

Brightness measured when LCD is at "white state"

$$\text{Contrast Ratio (CR)} = \frac{\text{Brightness measured when LCD is at "white state"}}{\text{Brightness measured when LCD is at "black state"}}$$

Brightness measured when LCD is at "black state"

d. Measured at the center area of the panel when all the input terminals of LCD panel are electrically opened.

Product Specification

	Model: GDTQ35SP7G2R0	Rev. No.	Issued Date.	Page.
		A	2010, APR.30	12 / 22

e. View Angle

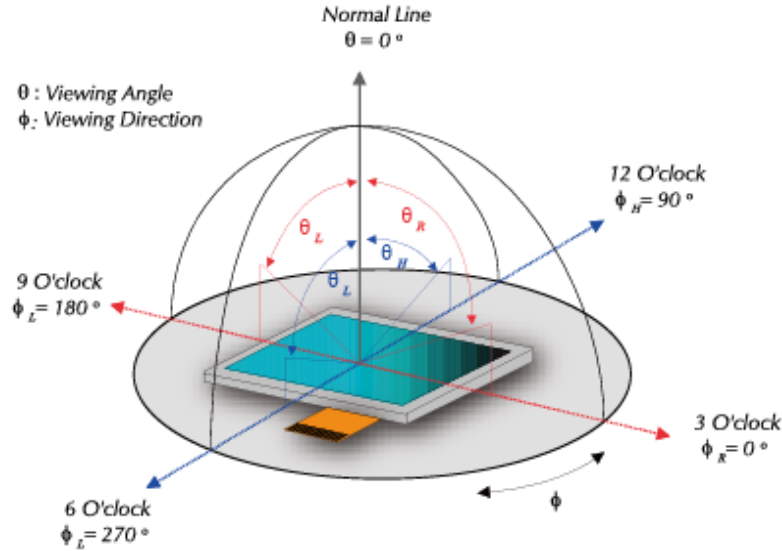

f. Definition of Luminance of White: Luminance of white at the center points

Light Source of Back-Light Unit	LED Type
---------------------------------	----------

g. Definition of White Uniformity

$$\text{White Uniformity} = \frac{\text{Min. luminance of white among 9-points}}{\text{Max. luminance of white among 9-points}} \times 100\%$$

h. The definition of Color Gamut -Color Chromaticity CIE 1931

Color coordinate of white & red, green, blue at center point.

Color Gamut : NTSC(%) = (RGB Triangle Area / NTSC Triangle Area) x 100

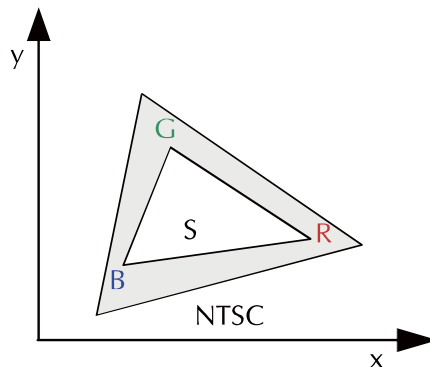

Product Specification

	Model: GDTQ35SP7G2R0	Rev. No.	Issued Date.	Page.
		A	2010, APR.30	13 / 22

7. Touch Screen Panel Specifications

7.1 Touch Panel

7.1.1 Electrical Characteristics

Item	Min.	Typ.	Max.	Unit	Note
Linearity	-1.5	-	1.5	%	Analog X and Y directions
Terminal resistance	200	-	700	Ω	X(Glass side)
	200	-	900	Ω	Y(Film side)
Insulation resistance	20	-	-	M Ω	DC 25V
Voltage	-	5.0	7.0	V	DC
Chattering	-	-	10	ms	100k Ω pull-up

Caution (1) : Do not operate it with a thing except a polyacetal pen (tip R0.8mm or less) or a finger, especially those with hard or sharp tips such as a ball point pen or a mechanical pencil.

7.1.2 Mechanical & Reliability Characteristics

Item	Min.	Typ.	Max.	Unit	Note
Activation force	-		80	g	(1)
Durability-surface scratching	Write 100,000	-	-	characters	(2)
Durability-surface pitting	1,000,000	-	-	touches	(3)
Surface hardness	3	-	-	H	JIS K5400,ASTM D3363

Note (1) Stylus pen Input : R0.8mm polyacetal pen or Finger

Note (2) Measurement for Surface area - Scratch 100,000 times straight line on the Film with a stylus change every 20,000times

- Force : 150gf
- Speed : 100mm/sec
- Stylus : R0.8 polyacetal tip

Note (2) Pit 1,000,000 times on the Film with a R8.0 silicon rubber.

- Force : Force : 250gf
- Speed : 3times/sec

8. Absolute Maximum Ratings

Product Specification

	Model: GDTQ35SP7G2R0	Rev. No.	Issued Date.	Page.
		A	2010, APR.30	14 / 22

8.1 Absolute Ratings of Environment

If the operating condition exceeds the following absolute maximum ratings, the TFT LCD module may be damaged permanently.

(Ta=25±2°C, V_{SS}=GND=0)

Item	Symbol	Min.	Max.	Unit	Note
Storage temperature	T _{STG}	-20	70	°C	(1)
Operating temperature (Ambient temperature)	T _{OPR}	-10	60	°C	(1)

Note (1) 95 % RH Max. (40 °C ≥ Ta)

Maximum wet-bulb temperature at 39 °C or less. (Ta > 40 °C) No condensation.

8.2 Electrical Absolute Rating

8.2.1 TFT-LCD Module

(Voltage Referenced to GND=V_{SS})

Item	Symbol	Value		Unit	Condition
		Min.	Max.		
Supply Voltage	VDDIO	-0.3	+4.0	V	--
Supply Voltage	VCI	VSS-0.3	5.0	V	--

8.2.2 Back-Light Unit

(Ta=25±2°C)

Item	Symbol	Min.	Max.	Unit	Note
Current	I _f	--	30	mA	(1)

Note (1) Permanent damage to the device may occur if maximum values are exceeded or reverse voltage is loaded. Functional operation should be restricted to the conditions described under normal operating conditions.

Product Specification

	Model: GDTQ35SP7G2R0	Rev. No.	Issued Date.	Page.
		A	2010, APR.30	15 / 22

9. Electrical Characteristics

9.1 TFT-LCD Module (DC Characteristics)

(TA=25°C)

Item	Symbol	Condition	Value			Unit
			Min.	Typ.	Max.	
Logic Power Supply	V _{DDIO}		2.5	3.3	3.6	V
Boost Power Supply	V _{Cl}		2.5	3.3	3.6	V
Logic High Input voltage	V _{IH}		0.8 V _{DDIO}	-	V _{DDIO}	V
Logic Low Input voltage	V _{IL}		0	-	0.2 V _{DDIO}	
Logic Power current	I _{VDDIO}	V _{DDIO} =3.3V	-	0.5	-	mA
Boost Power current	I _{VCl}		-	7	-	mA

9.2 Backlight Unit

The back-light system is an edge-lighting type with six white LEDs (Light Emitting Diode).

(Ta=25±2°C)

Item	Symbol	Value			Unit	Condition
		Min.	Typ.	Max.		
Power Consumption	P _{LED}	-	(408)	-	mW	
Forward voltage	V _f	-	(19.8)	-		
LED Current	I _f	-	20	-	mA	

Note (1) Six LEDs serial type.

(2) Where I_f = 20mA, V_B = P_{LED} / I_f

Product Specification

	Model: GDTQ35SP7G2R0	Rev. No.	Issued Date.	Page.
		A	2010, APR.30	16 / 22

10. Basic Display Color and Gray Scale

	Color & Gray Scale	Data Signal																							
		R7	R6	R5	R4	R3	R2	R1	R0	G7	G6	G5	G4	G3	G2	G1	G0	B7	B6	B5	B4	B3	B2	B1	B0
Basic Color	Black	0	0	0	0	0	0	0	0	0	0	0	0	0	0	0	0	0	0	0	0	0	0	0	
	Red	1	1	1	1	1	1	1	1	0	0	0	0	0	0	0	0	0	0	0	0	0	0	0	
	Green	0	0	0	0	0	0	0	0	1	1	1	1	1	1	1	1	0	0	0	0	0	0	0	
	Blue	0	0	0	0	0	0	0	0	0	0	0	0	0	0	0	0	1	1	1	1	1	1	1	
	Cyan	0	0	0	0	0	0	0	0	1	1	1	1	1	1	1	1	1	1	1	1	1	1	1	
	Magenta	1	1	1	1	1	1	1	1	0	0	0	0	0	0	0	0	1	1	1	1	1	1	1	
	Yellow	1	1	1	1	1	1	1	1	1	1	1	1	1	1	1	1	0	0	0	0	0	0	0	
	White	1	1	1	1	1	1	1	1	1	1	1	1	1	1	1	1	1	1	1	1	1	1	1	
Red	Black	0	0	0	0	0	0	0	0	0	0	0	0	0	0	0	0	0	0	0	0	0	0		
	Red(1)	0	0	0	0	0	0	0	1	0	0	0	0	0	0	0	0	0	0	0	0	0	0		
	Red(2)	0	0	0	0	0	0	1	0	0	0	0	0	0	0	0	0	0	0	0	0	0	0		
	:	:	:	:	:	:	:	:	:	:	:	:	:	:	:	:	:	:	:	:	:	:	:		
	Red(127)	0	1	1	1	1	1	1	1	0	0	0	0	0	0	0	0	0	0	0	0	0	0		
	:	:	:	:	:	:	:	:	:	:	:	:	:	:	:	:	:	:	:	:	:	:	:		
	Red(254)	1	1	1	1	1	1	1	0	0	0	0	0	0	0	0	0	0	0	0	0	0	0		
	Red(255)	1	1	1	1	1	1	1	1	0	0	0	0	0	0	0	0	0	0	0	0	0	0		
Green	Black	0	0	0	0	0	0	0	0	0	0	0	0	0	0	0	0	0	0	0	0	0	0		
	Green(1)	0	0	0	0	0	0	0	0	0	0	0	0	0	0	1	0	0	0	0	0	0	0		
	Green(2)	0	0	0	0	0	0	0	0	0	0	0	0	0	1	0	0	0	0	0	0	0	0		
	:	:	:	:	:	:	:	:	:	:	:	:	:	:	:	:	:	:	:	:	:	:	:		
	Green(127)	0	0	0	0	0	0	0	0	1	1	1	1	1	1	1	0	0	0	0	0	0	0		
	:	:	:	:	:	:	:	:	:	:	:	:	:	:	:	:	:	:	:	:	:	:	:		
	Green(254)	0	0	0	0	0	0	0	0	1	1	1	1	1	1	1	0	0	0	0	0	0	0		
	Green(255)	0	0	0	0	0	0	0	0	1	1	1	1	1	1	1	0	0	0	0	0	0	0		
Blue	Black	0	0	0	0	0	0	0	0	0	0	0	0	0	0	0	0	0	0	0	0	0	0		
	Blue(1)	0	0	0	0	0	0	0	0	0	0	0	0	0	0	0	0	0	0	0	0	0	1		
	Blue(2)	0	0	0	0	0	0	0	0	0	0	0	0	0	0	0	0	0	0	0	0	0	1		
	:	:	:	:	:	:	:	:	:	:	:	:	:	:	:	:	:	:	:	:	:	:	:		
	Blue(127)	0	0	0	0	0	0	0	0	0	0	0	0	0	0	0	0	1	1	1	1	1	1		
	:	:	:	:	:	:	:	:	:	:	:	:	:	:	:	:	:	:	:	:	:	:	:		
	Blue(254)	0	0	0	0	0	0	0	0	0	0	0	0	0	0	0	1	1	1	1	1	1	0		
	Blue(255)	0	0	0	0	0	0	0	0	0	0	0	0	0	0	0	1	1	1	1	1	1	1		

0 : Low level voltage, 1 :High level voltage

Each basic color can be displayed in 256 gray scales from 8 bit data signals. With the combination of total 24 bit data signals, the 16,777,216-color display can be achieved on the screen.

Product Specification

	Model: GDTQ35SP7G2R0	Rev. No.	Issued Date.	Page.
		A	2010, APR.30	17 / 22

11. AC Timing

11.1 AC Characteristics (Pixel Timing)

(Unless otherwise specified, Voltage Referenced to VSS, VDDIO = 2.8V, TA = 25°C)

Item	Symbol	Min.	Typ.	Max.	Unit
DOTCLK Frequency	fDOTCLK	-	6.5	10	MHz
DOTCLK Period	tDOTCLK	100	154	-	ns
Vertical Sync Setup Time	tvsys	20	-	-	ns
Vertical Sync Hold Time	tvsyh	20	-	-	ns
Horizontal Sync Setup Time	thsys	20	-	-	ns
Horizontal Sync Hold Time	thsyh	20	-	-	ns
Phase difference of Sync Signal Falling Edge	thv	1	-	240	tDOTCLK
DOTCLK Low Period	tCKL	50	-	-	ns
DOTCLK High Period	tCKH	50	-	-	ns
Data Setup Time	tds	12	-	-	ns
Data hold Time	tdh	12	-	-	ns
Reset pulse width	tRES	10	-	-	us

Note: External clock source must be provided to DOTCLK pin of HX8238-A. The driver will not operate if absent of the clocking signal.

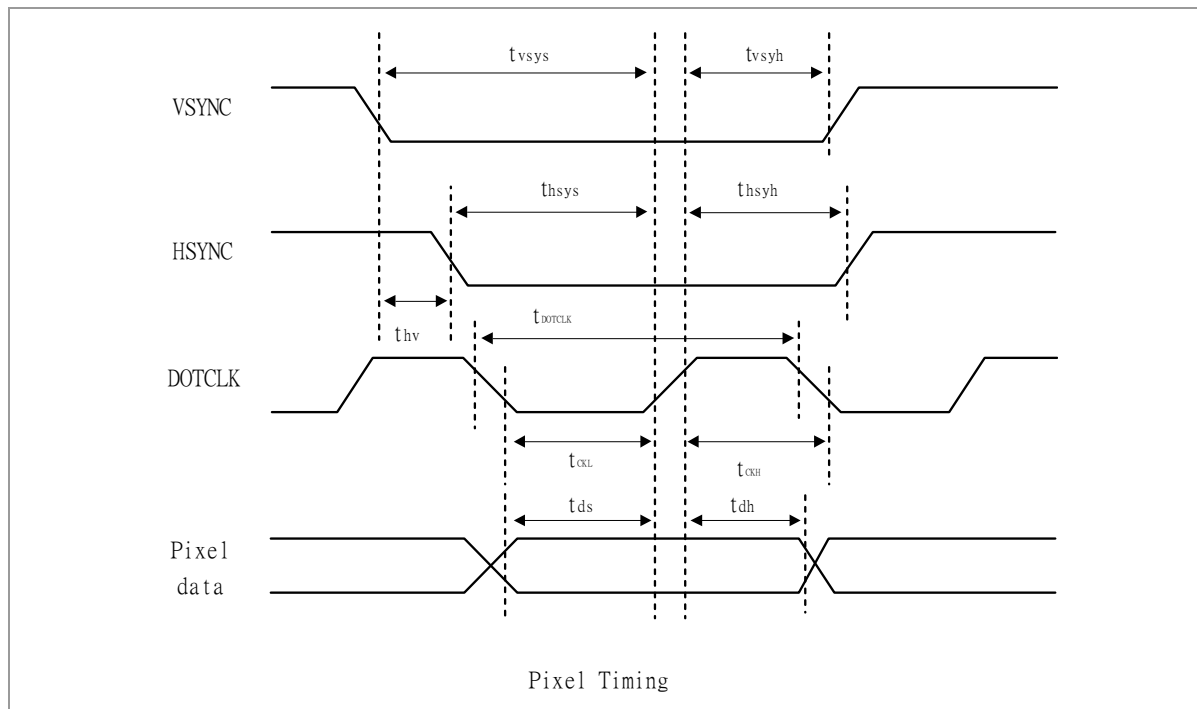

Product Specification



Model: GDTQ35SP7G2R0

Rev. No.

Issued Date.

Page.

A

2010, APR.30

18 / 22

11.2 SPI Timing Characteristics

Item	Symbol	Min.	Typ.	Max.	Unit
Serial Clock Frequency	fclk	-	-	20	MHz
Serial Clock Cycle Time	tclk	50	-	-	ns
Clock Low Width	tsl	25	-	-	ns
Clock High Width	tsh	25	-	-	ns
Chip Select Setup Time	tcss	0	-	-	ns
Chip Select Hold Time	tcsH	10	-	-	ns
Chip Select High Delay Time	tcsd	20	-	-	ns
Data Setup Time	tds	5	-	-	ns
Data Hold Time	tdh	10	-	-	ns

11.3 Write SPI interface Timing Diagram

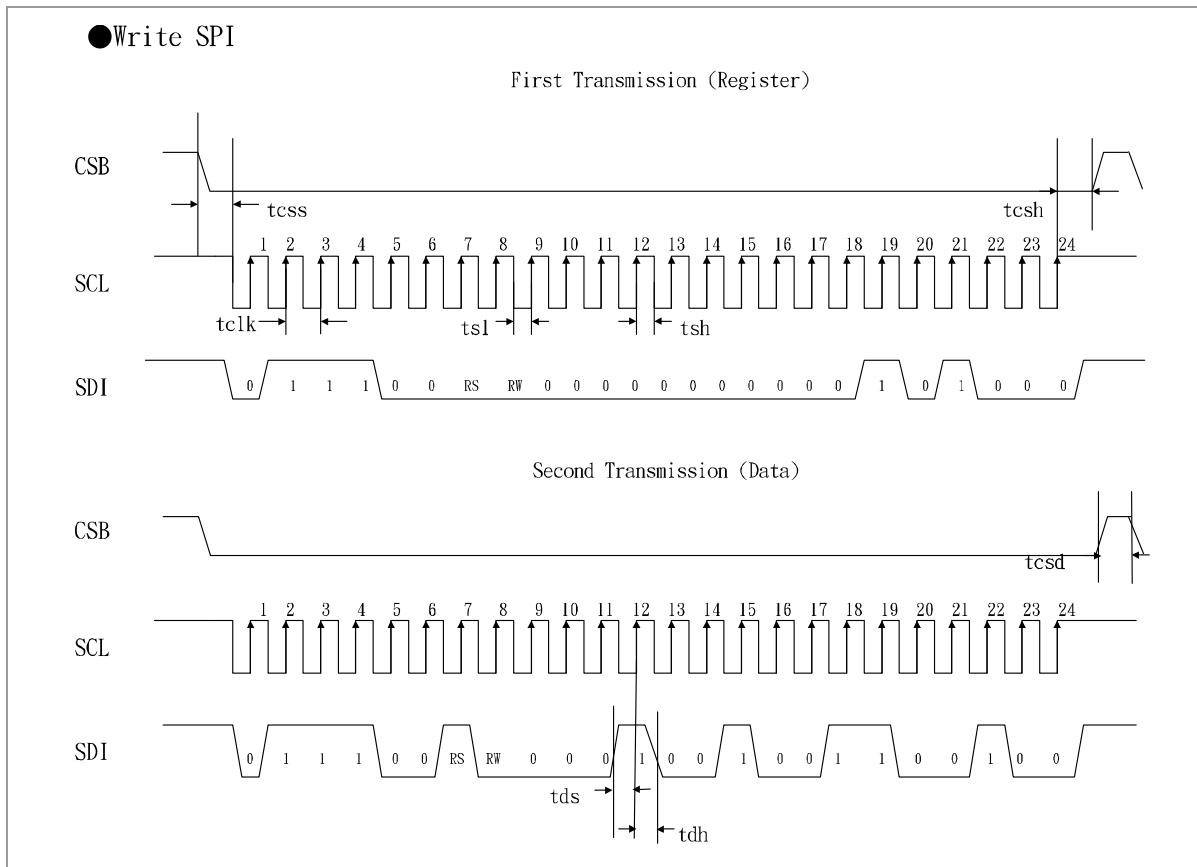

Note: The example writes "0x1264h" to register R28h.

SPID connected to VSS.

Product Specification

	Model: GDTQ35SP7G2R0	Rev. No.	Issued Date.	Page.
		A	2010, APR.30	19 / 22

11.4 Read SPI interface Timing Diagram

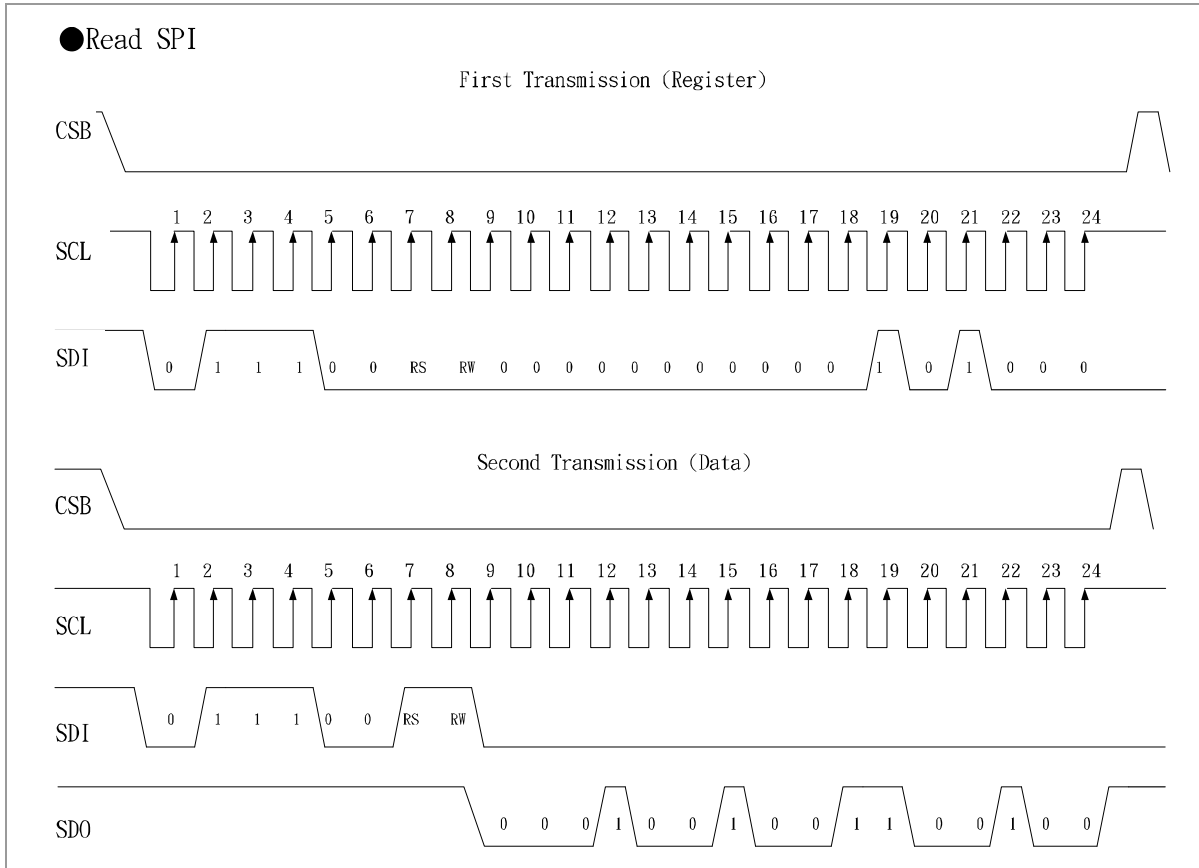

Note: The example Read "0x1264h" from register R28h.

Product Specification

	Model: GDTQ35SP7G2R0	Rev. No.	Issued Date.	Page.
		A	2010, APR.30	20 / 22

11.5 AC Characteristics

Item	Symbol	Min.	Typ.	Max.	Unit	
DOTCLK Frequency	fDOTCLK	-	6.5	10	MHz	
DOTCLK Period	tDOTCLK	100	154	-	ns	
Horizontal Frequency (Line)	fH	-	14.9	22.35	KHz	
Vertical Frequency (Refresh)	fV	-	60	90	Hz	
Horizontal Back Porch	tHBP	-	68	-	tDOTCLK	
Horizontal Front Porch	tHFP	-	20	-	tDOTCLK	
Horizontal Data Start Point	tHBP	-	68	-	tDOTCLK	
Horizontal Blanking Period	tHBP + tHFP	-	88	-	tDOTCLK	
Horizontal Display Area	HDISP	-	320	-	tDOTCLK	
Horizontal Cycle	Hcycle	-	408	450	tDOTCLK	
Vertical Back Porch	tVBP	-	18	-	Lines	
Vertical Front Porch	tVFP	-	4	-	Lines	
Vertical Data Start Point	tVBP	-	18	-	Lines	
Vertical Blanking Period	tVBP + tVFP	-	22	-	Lines	
Vertical Display Area	NTSC	VDISP	-	240	-	Lines
	PAL		280(PALM=0)			
			288(PALM=1)			
Vertical Cycle	NTSC	Vcycle	-	262	350	Lines
	PAL		313			

Product Specification



Model: GDTQ35SP7G2R0

Rev. No.

Issued Date.

Page.

A

2010, APR.30

21 / 22

11.6 Timing in Parallel RGB (24 bit SYNC Mode)

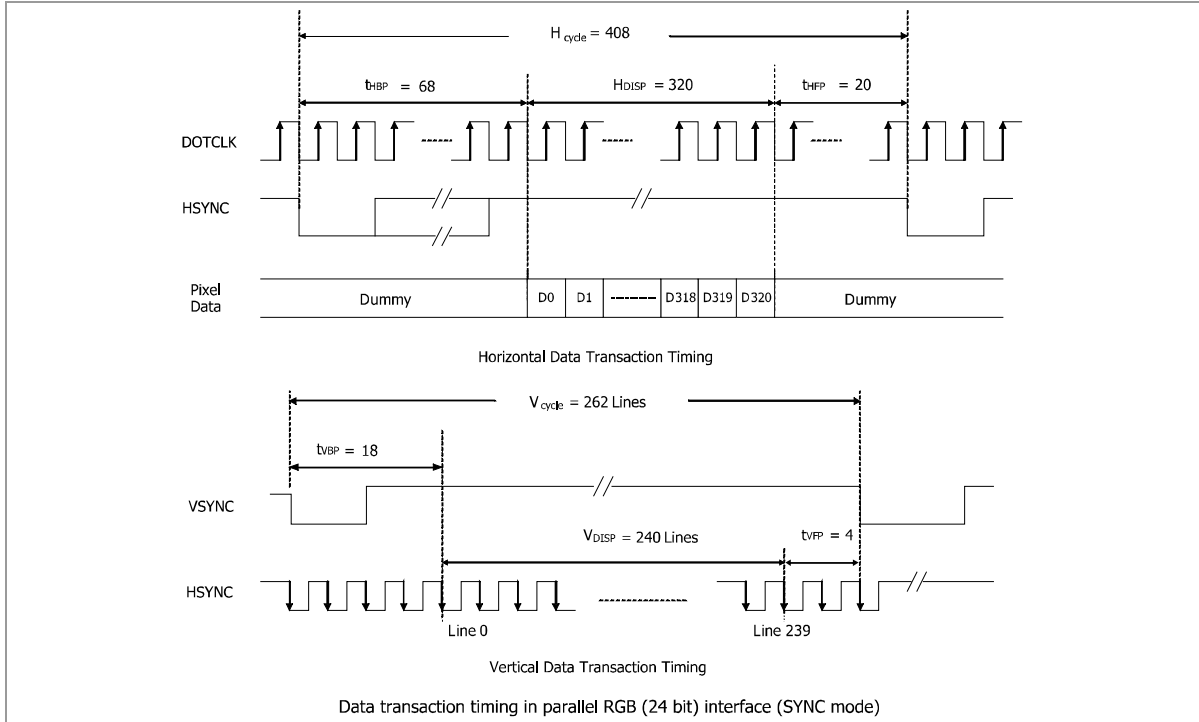

11.7 Timing in Parallel RGB (24 bit DE Mode)

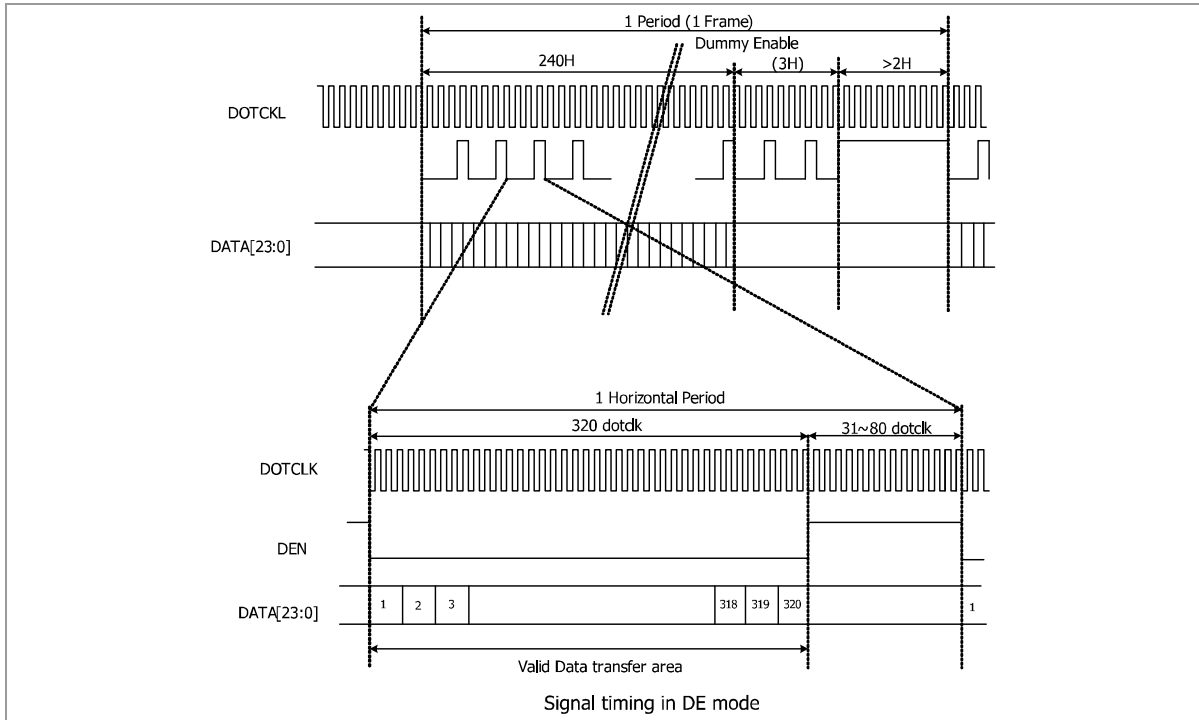

Product Specification

	Model: GDTQ35SP7G2R0	Rev. No.	Issued Date.	Page.
		A	2010, APR.30	22 / 22

12. Reliability Condition for LCD

12.1 Main LCD Reliability Test

No.	Panel	Item	Condition	Test time	Note
1	√	High temp. operating	60°C	120 Hrs	--
2	√	Low temp. operating	-10°C	120 Hrs	--
3	√	High temp. storage	70°C	120 Hrs	--
4	√	Low temp. storage	-20°C	120 Hrs	--
5	√	High Temp / High Humidity Storage	T = 60°C /85%. For (But no condensation dew)	120 Hrs	--
6	√	High Temp/ High Humidity Operating	T = 40°C /85% For (But no condensation dew)	120 Hrs	--
7	√	Thermal Shock (Non-Operation)	-10 ← → 60°C, 50 cycle 30min 30min	1 Hrs	--
8	√	Vibration (Non-Operation)	Frequency:10 ~ 55Hz, mp:1.5mm Sweep Time : 11min Test Time : 2hrs for each direction of X,Y,Z	--	--
9	√	Drop (Non-Operation)	Acceleration : 100G, Period : 6ms Directions of X,Y,Z Cycles: Twice	--	--