

Product Specification

	Model: GTTV57NN771E0	Rev. No.	Issued Date.	Page.
		A	FEB. 19, 08	1 / 27



**Thin-Film-Transistor LCD Module
Model: GTTV57NN771E0**

Acceptance

Solomon Goldentek Display Corp.

5F, No. 42, Shing Zhong Rd.,
Nei Hu, Taipei 114, Taiwan
FAX: 886-2-87919825

Approved and Checked by

Approved by	Checked by		Made by
			

Product Specification				
	Model: GTTV57NN771E0	Rev. No.	Issued Date.	Page.
		A	FEB. 19, 08	3 / 27

Contents

- 1. GENERAL DESCRIPTION AND FEATURES.....4**
 - 1.1 Features4
 - 1.2 LCD Module4
- 2. MECHANICAL INFORMATION.....4**
- 3. ELECTRICAL SPECIFICATIONS5**
 - 3.1 Absolute Max. Ratings5
 - 3.2 Electrical Characteristics7
 - 3.3 AC Timing Characteristic of The LCD8
 - 3.4 Back-Light Unit.....10
- 4. OPTICAL CHARACTERISTICS.....11**
 - 4.1 Optical characteristic of the LCD.....11
- 5 I/O TERMINAL14**
 - 5.1 Pin Assignment14
 - 5.2 Block Diagram16
 - 5.3 Back-light Unit (BLU)16
 - 5.4 Basic Display Color and Gray Scale.....17
- 6 TEST18**
- 7 APPEARANCE19**
- 8 PRECAUTIONS23**
 - 8.1 Operation23
 - 8.2 Safety23
 - 8.3 Handling.....23
 - 8.4 Static electricity.....25
 - 8.5 Storage.....25
 - 8.6 Cleaning25
 - 8.7 Waste.....25
- 9 WARRANTY.....26**
- 10 DIMENSIONAL OUTLINES.....27**

Product Specification

	Model: GTTV57NN771E0	Rev. No.	Issued Date.	Page.
		A	FEB. 19, 08	4 / 27

1. GENERAL DESCRIPTION AND FEATURES

GTTV57NN771E0 is a transmissive type color active matrix TFT (Thin Film Transistor) liquid crystal display (LCD) that uses amorphous silicon TFT as a switching device. This model is composed of a TFT-LCD module, a driver circuit and a back-light unit. Graphics and texts can be displayed on a VGA 640 (W) x 3 x 480 (H) dots with 262,144 colors by supplying 18 bits data signal (6bits/each color). The following table described the features of GTTV57NN771E0.

1.1 Features

- Transmissive and back-light with Eighteen LEDs are available.
- TN (Twisted Nematic) mode.
- Digital RGB (6bits/color) data transfer.

1.2 LCD Module

Item	Specification	Unit
Screen Size	5.7 inches	Diagonal
Display Resolution	640 (H) x 480 (V)	Pixel
Active Area	115.20 (H) x 86.40 (V)	mm
Outline Dimension	144.00 (H) x 104.60 (V) x 12.80 (T)	mm
Display Mode	Normally white mode/ Transmissive/ Wide view	--
Pixel Arrangement	R,G,B Vertical Tripe	--
Pixel size	181.5 x 181.5	um
Display Color	Full Colors	--
Viewing Direction	12 o'clock	--
Input Interface	Digital RGB (6bits/color) Data Transfer	--
TFT Driver	Source: HX8250, Gate: HX8678	--

2. MECHANICAL INFORMATION

Item	Min.	Typ.	Max.	Unit	Note
Module Size	Horizontal (H)	--	144.00	--	mm (1)
	Vertical (V)	--	104.60	--	mm (1)
	Thickness (T)	--	12.80	--	mm (1)
Weight	--	N/A	--	g	--

Note (1) Excluding backlight cables. . Refer to the Outline Dimension Drawing as attached.

Product Specification

	Model: GTTV57NN771E0	Rev. No.	Issued Date.	Page.
		A	FEB. 19, 08	5 / 27

3. ELECTRICAL SPECIFICATIONS

3.1 Absolute Max. Ratings

3.1.1 Absolute Ratings of Environment

If the operating condition exceeds the following absolute maximum ratings, the TFT LCD module may be damaged permanently.

(Ta=25±2°C, V_{SS}=GND=0)

Item	Symbol	Min.	Max.	Unit	Note
Storage temperature	T _{STG}	-20	70	°C	(1)
Operating temperature	T _{OPR}	-10	60	°C	(1,2,3)

Note (1) 95 % RH Max. (40 °C ≥ Ta). Maximum wet-bulb temperature at 39 °C or less. (Ta > 40 °C) No condensation.

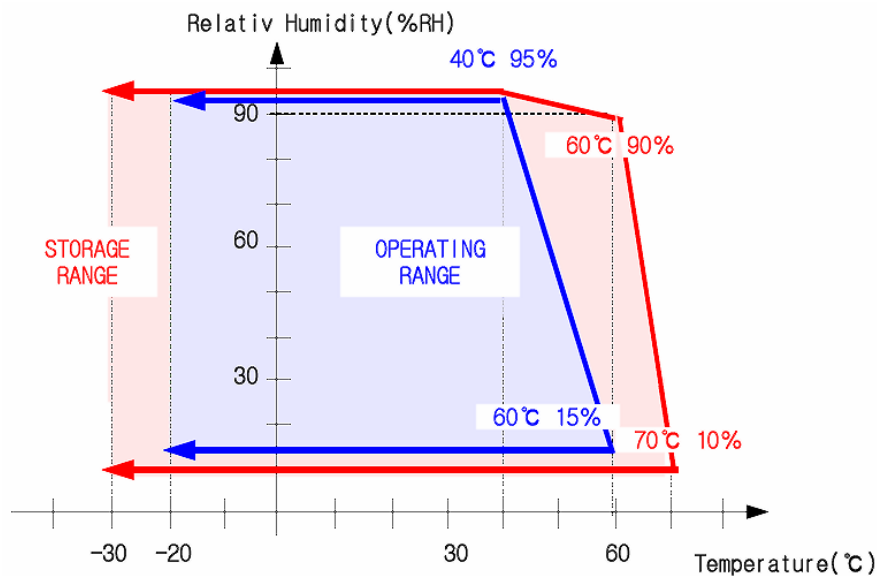

Note (2) In case of below 0°, the response time of liquid crystal (LC) becomes slower and the color of panel becomes darker than normal one. Level of retardation depends on temperature, because of LC's character

Note (3) Only operation is guaranteed at operating temperature. Contrast, response time, another display quality are evaluated at +25°C.

Product Specification

	Model: GTTV57NN771E0	Rev. No.	Issued Date.	Page.
		A	FEB. 19, 08	6 / 27

3.1.2 Electrical Absolute Maximum Ratings

($V_{SS}=GND=0$)

Parameter	Symbol	Min.	Max.	Unit	Remark
Power supply voltage	V_{CC}	-0.3	5.0	V	
Signal input voltage	R0-R5,G0-G5, B0-B5,DCLK,DE	-0.3	$V_{CC}+0.3$	V	--
Permissive input ripple voltage	V_{RF}	--	100	mVp-p	$V_{CC} = +3.3V$

Display On/Off Sequence :

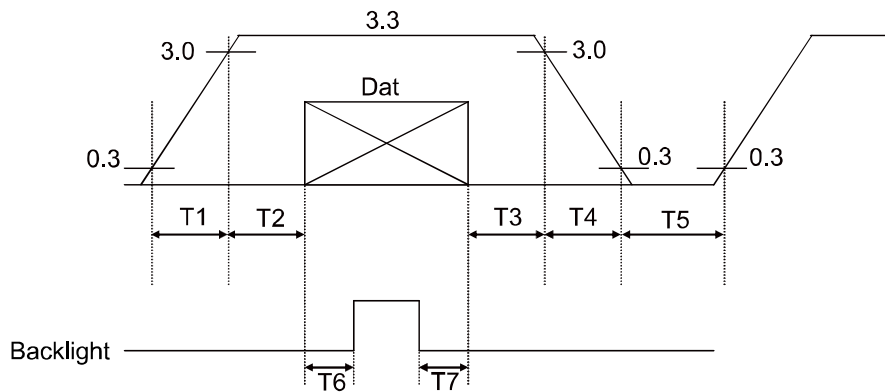

Data: DCLK, R0 ~ R5, G0 ~ G5, B0 ~ B5, DE

$T1 \leq 10ms$, $50ms \leq T2$, $0 < T3 \leq 50ms$, $0 < T4 \leq 10ms$, $1s \leq T5$, $200ms \leq T6$, $200ms \leq T7$

Product Specification

	Model: GTTV57NN771E0	Rev. No.	Issued Date.	Page.
		A	FEB. 19, 08	7 / 27

3.2 Electrical Characteristics

3.2.1 DC Electrical Characteristics of the TFT LCD

(Ta=25±2°C, V_{SS}=GND=0)

Item	Symbol	Min.	Typ.	Max.	Unit	Remark
Power supply	VCC	3.0	3.3	3.6	V	Note 1
Input Voltage for logic	H Level	0.7VDD	-	VDD	V	
	L Level	0	-	0.3VDD	V	
Power Supply current	ICC		120	T.B.D	mA	Note 2

Note1: Vcc-dip conditions

Vcc-dip conditions should also follow the Vcc-turn-on conditions

Td ≤ 10ms

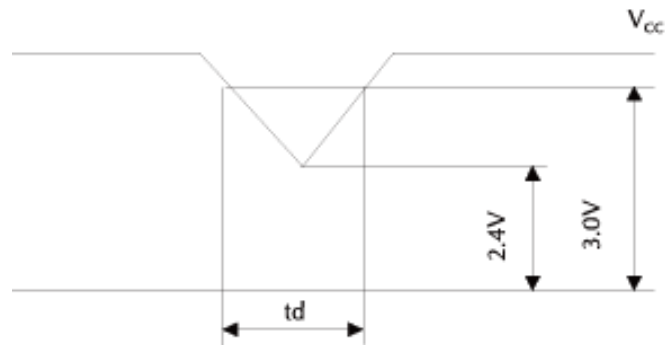

Note2: fv =60Hz , Ta=25°C , Display pattern : 64 Gray pattern

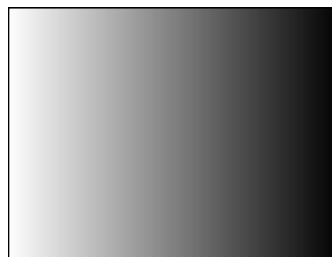

Product Specification

	Model: GTTV57NN771E0	Rev. No.	Issued Date.	Page.
		A	FEB. 19, 08	8 / 27

3.3 AC Timing Characteristic of The LCD

3.3.1 Timing Condition

Parameter	Symbol	Min.	Typ.	Max.	Unit.	Remark
CLK frequency	F_{CPH}	--	25.175	--	MHZ	
CLK period	T_{CPH}	--	39.7	--	ns	
CLK pulse duty	T_{CWH}	40	50	60	%	
HS period	T_H	--	800	--	T_{CPH}	
HS pulse width	T_{WH}	5	30	--	T_{CPH}	
HS-DEN time	T_{HS}	112	144	175	T_{CPH}	
DEN pulse width	T_{EP}	--	640	--	T_{CPH}	
VS pulse width	T_{WV}	1	3	5	T_H	
VS-DEN time	T_{STV}	--	35	--	T_H	
VS period	T_V	--	525	--	T_H	

Note : When SYNC mode is used, 1st data start from 144th CLK after HS falling (when $STHD[5:0]=00000$)

Parameter	Symbol	Min.	Typ.	Max.	Unit.	Remark
OEV pulse width	T_{CVE}	--	100	--	T_{CPH}	
CKV pulse width	T_{CKV}	--	96	--	T_{CPH}	
HS-CKV time	T_1	--	52	--	T_{CPH}	
HS-OEV tim	T_2	--	8	--	T_{CPH}	
HS-POL time	T_3	--	72	--	T_{CPH}	
STV setup time	T_{SUV}	--	46	--	T_{CPH}	
STV pulse width	T_{WSTV}	--	1	--	T_H	

Product Specification



Model: GTTV57NN771E0

Rev. No.

Issued Date.

Page.

A

FEB. 19, 08

9 / 27

3.3.2 Clock and Data input waveforms

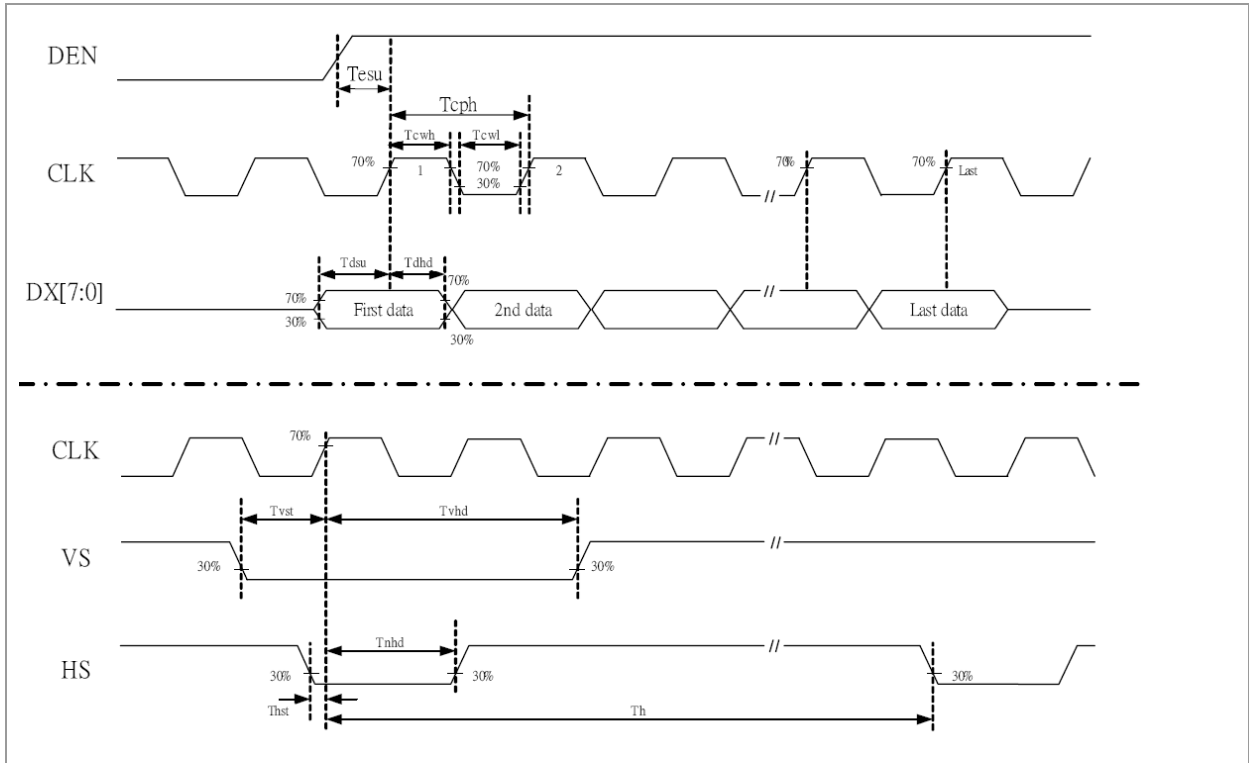

3.3.3 Data input format for parallel RGB Mode

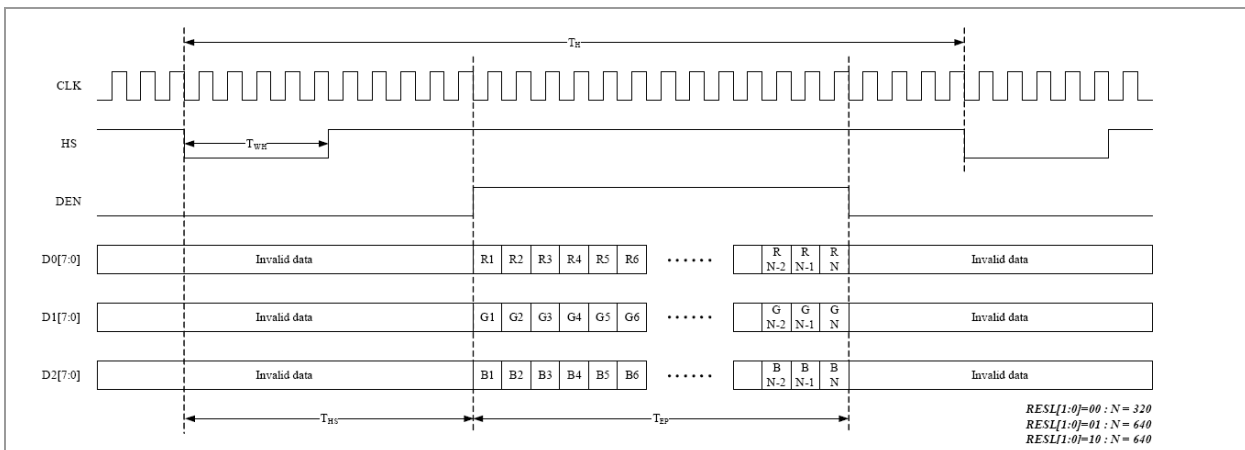

Product Specification

	Model: GTTV57NN771E0	Rev. No.	Issued Date.	Page.
		A	FEB. 19, 08	10 / 27

3.3.4 Digital RGB mode Horizontal timing for RESL[1:0]=10

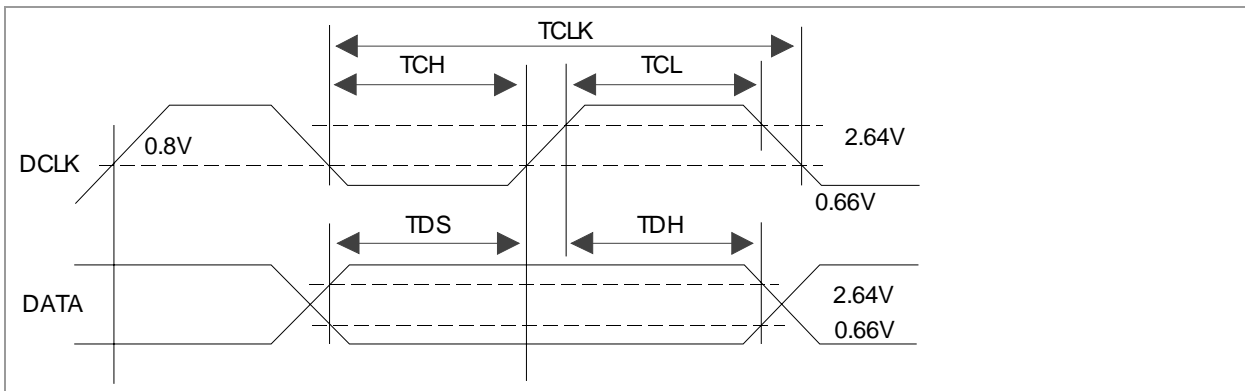
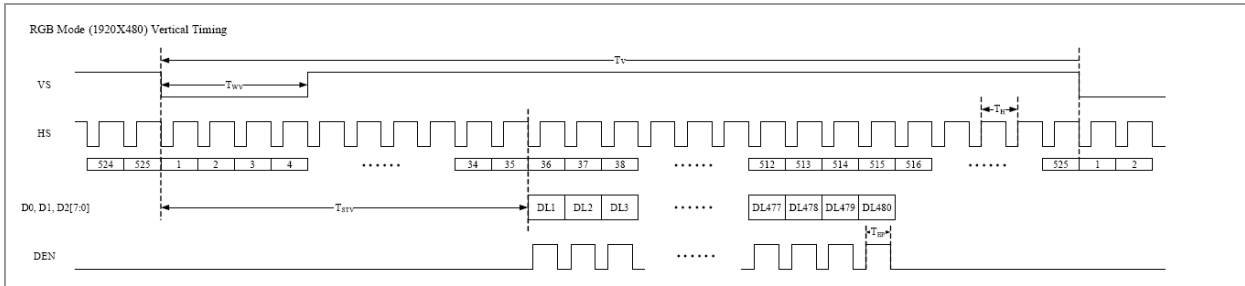

3.4 Back-Light Unit

The Back-light system is an edge-lighting type with 18 white LEDs(Light Emitting Diode). The characteristics of 18 white LEDs are shown in the following tables.

(Ta= Room Temp)

Characteristics	Symbol	Min.	Typ.	Max.	Unit	Note
Current	I_B	-	120	TBD	mA	(1)
Power Consumption	P_{BL}	-	1224		mW	(2)

Note (1) LEDs in 3 series x 6 parallel type.

(2) Where $I_B = 120\text{mA}$, $V_F = 10.2$, $P_{BL} = V_F \times I_B$

Product Specification

	Model: GTTV57NN771E0	Rev. No.	Issued Date.	Page.
		A	FEB. 19, 08	11 / 27

4. OPTICAL CHARACTERISTICS

4.1 Optical characteristic of the LCD

The following items are measured under stable conditions. The optical characteristics should be measured in a dark room or equivalent state with the methods shown in Note (1).

Measuring equipment: BM-5A, BM-7

Item	Symbol	Condition	Min	Type	Max	Unit	Note
Brightness			250	300	--	cd/m ²	
Response time	T _r	θ=0°	-	15	20	ms	.
	T _f		--	25	35	ms	
Contrast ratio	CR	At optimized viewing angle	300	350	--	--	
Color Gamut	NTSC %	--	--	50	--	%	
Color Chromaticity (CIE 1931)	Red	R _x	θ=0° Normal Viewing Angle	0.565	0.615	0.665	--
		R _y		0.294	0.344	0.394	
	Green	G _x		0.257	0.307	0.357	--
		G _y		0.512	0.562	0.612	
	Blue	B _x		0.090	0.140	0.190	--
		B _y		0.080	0.130	0.180	
	White	W _x		0.259	0.309	0.359	--
		W _y		0.300	0.350	0.400	
Viewing Angle (12H)	Hor.	θ _R	CR≥10	55	65	--	Degree
		θ _L		55	65	--	
	Ver.	φ _H		55	65	--	
		φ _L		40	50	--	

Product Specification

	Model: GTTV57NN771E0	Rev. No.	Issued Date.	Page.
		A	FEB. 19, 08	12 / 27

a. Test equipment setup

After stabilizing and leaving the panel alone shall be warmed up for the stable operation of LCM, the measurement should be executed. Measurement should be executed in a stable, windless, and dark room. Optical specifications are measured by Topcon BM-7(fast) with a viewing angle of 2° at a distance of 50cm and normal direction.

b. Definition of response time: Tr and Tf

The response time is defined as the following figure and shall be measured by switching the input signal for "black" and "white".

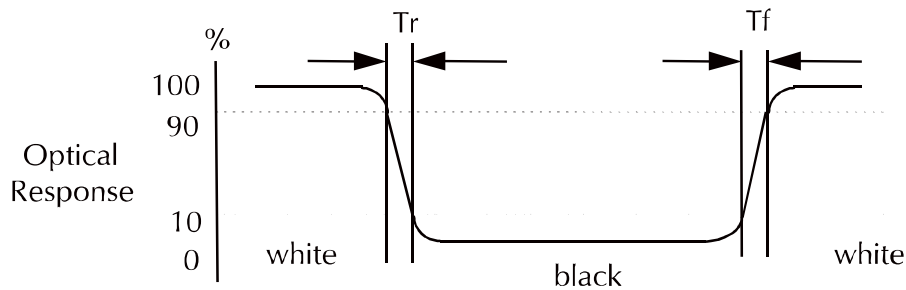

c. Definition of contrast ratio:

$$\text{Contrast Ratio (CR)} = \frac{\text{Brightness measured when LCD is at "white state"}}{\text{Brightness measured when LCD is at "black state"}}$$

d. Measured at the center area of the panel when all the input terminals of LCD panel are electrically opened.

Product Specification



Model: GTTV57NN771E0	Rev. No.	Issued Date.	Page.
	A	FEB. 19, 08	13 / 27

e. View Angle

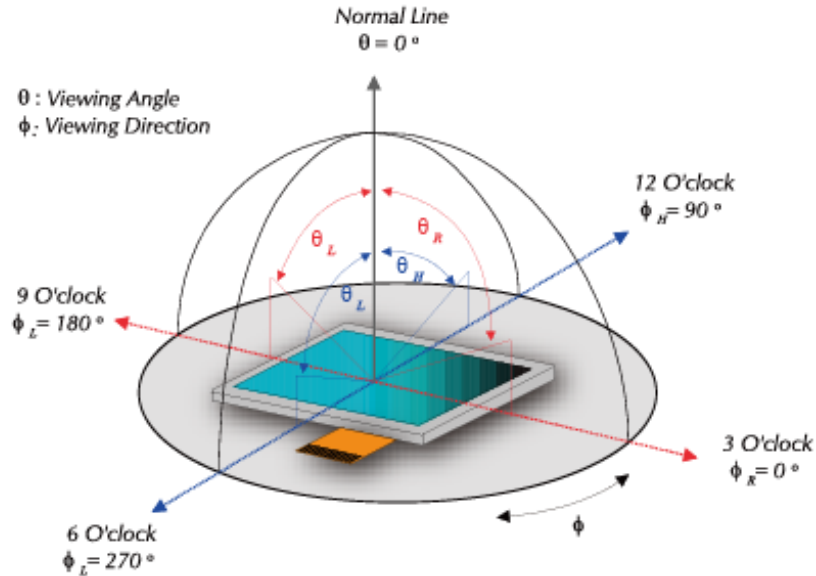

f. Definition of Luminance of White: Luminance of white at the center points

Light Source of Back-Light Unit	LED Type
---------------------------------	----------

g. Definition of White Uniformity

$$\text{White Uniformity} = \frac{\text{Min. luminance of white among 5-points}}{\text{Max. luminance of white among 5-points}} \times 100\%$$

h. The definition of Color Gamut -Color Chromaticity CIE 1931

Color coordinate of white & red, green, blue at center point.

$$\text{Color Gamut : NTSC(\%)} = (\text{RGB Triangle Area} / \text{NTSC Triangle Area}) \times 100$$

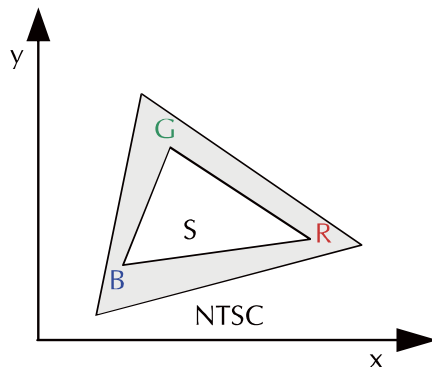

Product Specification

	Model: GTTV57NN771E0	Rev. No.	Issued Date.	Page.
		A	FEB. 19, 08	14 / 27

5 I/O TERMINAL

5.1 Pin Assignment

Pin No.	Symbol	I/O	Function	Remark
1	DGND	--	GND	
2	DCLK	I	Clock signal for sampling each data signal	
3	Hsync	I	Horizontal synchronous signal (Negative)	
4	Vsync	I	Vertical synchronous signal (Negative)	
5	GND	I	GND	
6	R0	I	RED data signal (LSB)	
7	R1	I	RED data signal	
8	R2	I	RED data signal	
9	R3	I	RED data signal	
10	R4	I	RED data signal	
11	R5	I	RED data signal (MSB)	
12	GND	--	GND	
13	G0	I	GREEN data signal (LSB)	
14	G1	I	GREEN data signal	
15	G2	I	GREEN data signal	
16	G3	I	GREEN data signal	
17	G4	I	GREEN data signal	
18	G5	I	GREEN data signal (MSB)	
19	GND	--	GND	
20	B0	I	BLUE data signal(LSB)	
21	B1	I	BLUE data signal	
22	B2	I	BLUE data signal	
23	B3	I	BLUE data signal	
24	B4	I	BLUE data signal	
25	B5	I	BLUE data signal(MSB)	
26	GND	--	GND	
27	DEN	I	Signal to settle the horizontal display position (Positive)	Note5-1
28	VCC	--	+ 3.3V power supply	
29	VCC	--	+ 3.3V power supply	
30	LRC	I	Horizontal display mode select signal H: Normal L: Left / Right reverse mode	Note5-2
31	UDC	I	Vertical display mode select signal L: Normal H: Up / Down reverse mode	Note5-3
32	NC	--	No Connection	
33	GND	I	GND	

Product Specification

	Model: GTTV57NN771E0	Rev. No.	Issued Date.	Page.
		A	FEB. 19, 08	15 / 27

Note5 - 1 The horizontal display start timing is settled in accordance with a rising timing of ENAB signal. In case ENAB is fixed "Low", the horizontal start timing is determined. Don't keep ENAB "High" during operation.

Note 5 - 2, 3

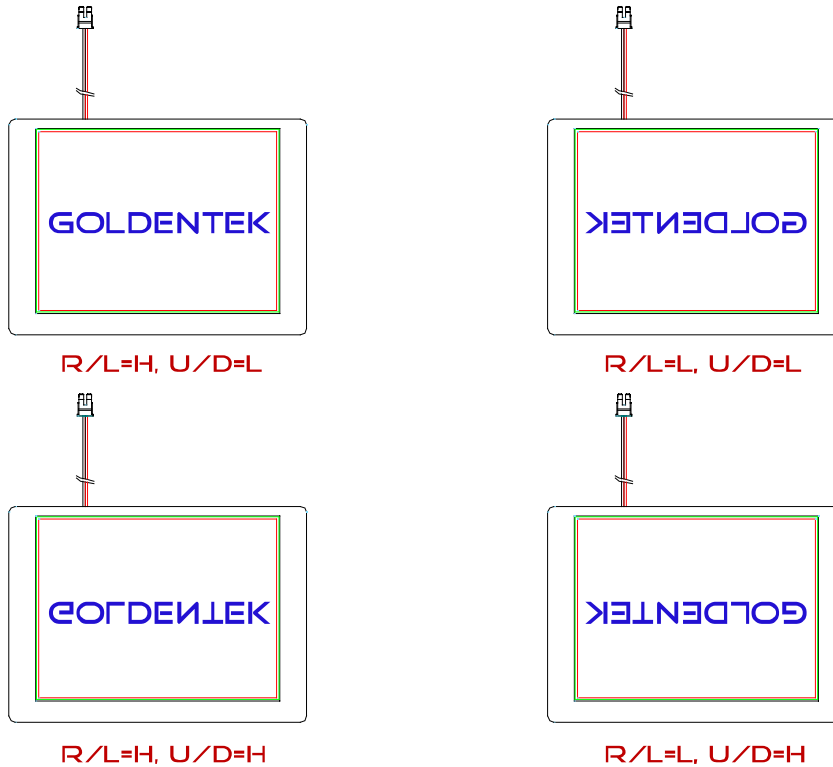

Product Specification

	Model: GTTV57NN771E0	Rev. No.	Issued Date.	Page.
		A	FEB. 19, 08	16 / 27

5.2 Block Diagram

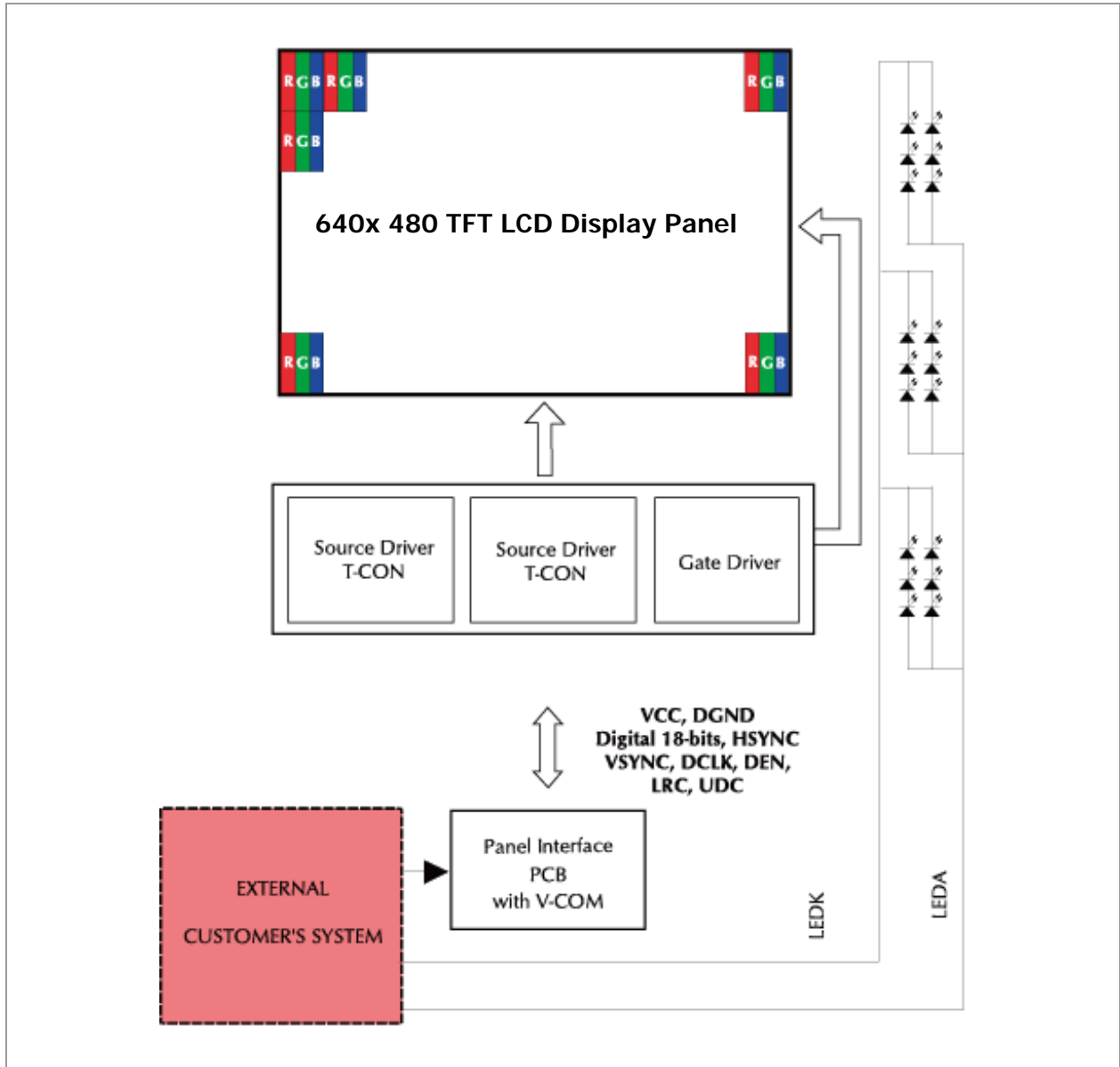

5.3 Back-light Unit (BLU)

Pin No.	Symbol	Function	Remark
1	LEDA	Power Supply for LED backlight	
2	LEDK	GND for LED backlight	

Product Specification

	Model: GTTV57NN771E0	Rev. No.	Issued Date.	Page.
		A	FEB. 19, 08	17 / 27

5.4 Basic Display Color and Gray Scale

	Color & Gray Scale	Data Signal																							
		R7	R6	R5	R4	R3	R2	R1	R0	G7	G6	G5	G4	G3	G2	G1	G0	B7	B6	B5	B4	B3	B2	B1	B0
Basic Color	Black	0	0	0	0	0	0	0	0	0	0	0	0	0	0	0	0	0	0	0	0	0	0	0	0
	Red(0)	1	1	1	1	1	1	1	1	0	0	0	0	0	0	0	0	0	0	0	0	0	0	0	0
	Green(0)	0	0	0	0	0	0	0	0	1	1	1	1	1	1	1	1	0	0	0	0	0	0	0	0
	Blue(0)	0	0	0	0	0	0	0	0	0	0	0	0	0	0	0	0	1	1	1	1	1	1	1	1
	Cyan	0	0	0	0	0	0	0	0	1	1	1	1	1	1	1	1	1	1	1	1	1	1	1	1
	Magenta	1	1	1	1	1	1	1	1	0	0	0	0	0	0	0	0	1	1	1	1	1	1	1	1
	Yellow	1	1	1	1	1	1	1	1	1	1	1	1	1	1	1	1	0	0	0	0	0	0	0	0
	White	1	1	1	1	1	1	1	1	1	1	1	1	1	1	1	1	1	1	1	1	1	1	1	1
Red	Black	0	0	0	0	0	0	0	0	0	0	0	0	0	0	0	0	0	0	0	0	0	0	0	
	Red(1)	0	0	0	0	0	0	0	1	0	0	0	0	0	0	0	0	0	0	0	0	0	0	0	
	Red(2)	0	0	0	0	0	0	1	0	0	0	0	0	0	0	0	0	0	0	0	0	0	0	0	
	:	:	:	:	:	:	:	:	:	:	:	:	:	:	:	:	:	:	:	:	:	:	:	:	
	Red(31)	0	1	1	1	1	1	1	1	0	0	0	0	0	0	0	0	0	0	0	0	0	0	0	
	:	:	:	:	:	:	:	:	:	:	:	:	:	:	:	:	:	:	:	:	:	:	:	:	
	Red(62)	1	1	1	1	1	1	1	0	0	0	0	0	0	0	0	0	0	0	0	0	0	0	0	
	Red(63)	1	1	1	1	1	1	1	1	0	0	0	0	0	0	0	0	0	0	0	0	0	0	0	
Green	Black	0	0	0	0	0	0	0	0	0	0	0	0	0	0	0	0	0	0	0	0	0	0	0	
	Green(1)	0	0	0	0	0	0	0	0	0	0	0	0	0	0	0	1	0	0	0	0	0	0	0	
	Green(2)	0	0	0	0	0	0	0	0	0	0	0	0	0	0	1	0	0	0	0	0	0	0	0	
	:	:	:	:	:	:	:	:	:	:	:	:	:	:	:	:	:	:	:	:	:	:	:	:	
	Green(31)	0	0	0	0	0	0	0	0	0	1	1	1	1	1	1	1	0	0	0	0	0	0	0	
	:	:	:	:	:	:	:	:	:	:	:	:	:	:	:	:	:	:	:	:	:	:	:	:	
	Green(62)	0	0	0	0	0	0	0	0	1	1	1	1	1	1	1	0	0	0	0	0	0	0	0	
	Green(63)	0	0	0	0	0	0	0	0	1	1	1	1	1	1	1	1	0	0	0	0	0	0	0	
Blue	Black	0	0	0	0	0	0	0	0	0	0	0	0	0	0	0	0	0	0	0	0	0	0	0	
	Blue(1)	0	0	0	0	0	0	0	0	0	0	0	0	0	0	0	0	0	0	0	0	0	0	1	
	Blue(2)	0	0	0	0	0	0	0	0	0	0	0	0	0	0	0	0	0	0	0	0	0	0	1	
	:	:	:	:	:	:	:	:	:	:	:	:	:	:	:	:	:	:	:	:	:	:	:	:	
	Blue(31)	0	0	0	0	0	0	0	0	0	0	0	0	0	0	0	0	1	1	1	1	1	1	1	
	:	:	:	:	:	:	:	:	:	:	:	:	:	:	:	:	:	:	:	:	:	:	:	:	
	Blue(62)	0	0	0	0	0	0	0	0	0	0	0	0	0	0	0	1	1	1	1	1	1	1	0	
	Blue(63)	0	0	0	0	0	0	0	0	0	0	0	0	0	0	0	1	1	1	1	1	1	1	1	

0 : Low level voltage, 1 : High level voltage

Each basic color can be displayed in 64 gray scales from 6 bit data signals. With the combination of total 18 bit data signals, the 262,144-color display can be achieved on the screen.

Product Specification

	Model: GTTV57NN771E0	Rev. No.	Issued Date.	Page.
		A	FEB. 19, 08	18 / 27

6 TEST

No change on display and in operation under the following test condition.

Condition: Unless otherwise specified, tests will be conducted under the following condition.

Temperature: $20 \pm 5^\circ\text{C}$

Humidity: $65 \pm 5\% \text{RH}$

Tests will be not conducted under functioning state.

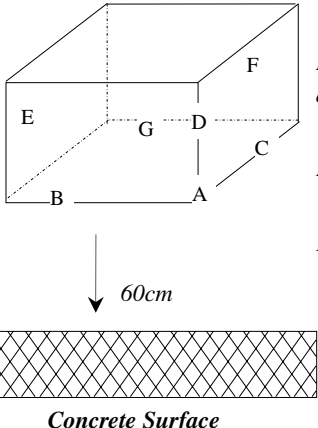
No.	Parameter	Condition	Notes
1	High Temperature Operating	$60^\circ\text{C} \pm 2^\circ\text{C}$, 96hrs (Operation state)	
2	Low Temperature Operating	$0^\circ\text{C} \pm 2^\circ\text{C}$, 96hrs (Operation state)	1
3	High Temperature Storage	$70^\circ\text{C} \pm 2^\circ\text{C}$, 96hrs	2
4	Low Temperature Storage	$-20^\circ\text{C} \pm 2^\circ\text{C}$, 96hrs	1,2
5	Damp Proof Test	$40^\circ\text{C} \pm 2^\circ\text{C}$, 90~95%, 96hrs	1,2
6	Vibration Test	Total fixed amplitude: 1.5mm Vibration Frequency: 10~55Hz One cycle 60 seconds to 3 direction of X, Y, Z each 15 minutes.	3
7.	Shock Test	To be measured after dropping from 60cm high on the concrete surface in packing state.  <div style="margin-left: 20px;"> <i>Dropping method corner dropping</i> <i>A corner: once</i> <i>Edge dropping</i> <i>B, C, D edge: once</i> <i>Face dropping</i> <i>E, F, G face: once</i> </div>	

- Notes:
1. No dew condensation to be observed.
 2. The function test shall be conducted after 4 hours storage at the normal temperature and humidity after removed from the test chamber.
 3. Vibration test will be conducted to the product itself without putting I in a container.

Product Specification

	Model: GTTV57NN771E0	Rev. No.	Issued Date.	Page.
		A	FEB. 19, 08	19 / 27

7 APPEARANCE

7.1 Inspection

The distance between the eyes and the sample shall be more than 30cm. All directions for inspecting the sample should be within 45° against perpendicular line.

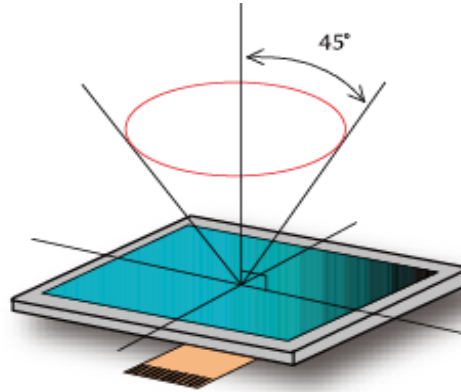

Definition of Applicable Zones

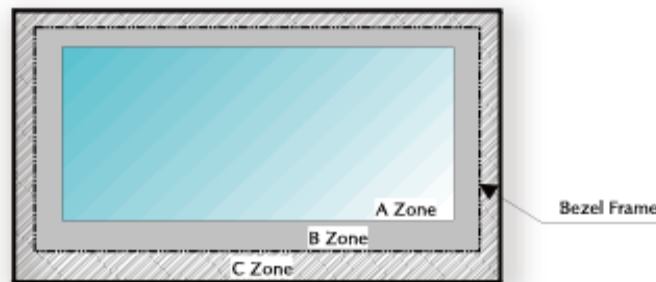

A Zone : Active display area, B Zone : Area from outside of "A Zone" to validity viewing area

C Zone : Rest parts, A Zone + B Zone = Validity viewing area

(a) Operating Inspection

The function and appearance shall be inspected in the condition of

- under 750 lx or over light Reflective Type.
- Using over Backlight unit Transflective Type, Transmissive Type

Condition of judgment

In case of no gradation display it judges by applied On/Off voltage or optimal contrast.

In case of gradation display it judges by contrast that the bad point is able to confirm best.

(b) Appearance Inspection

The appearance shall be inspected in the condition of

- under 500 lx or over light Reflective Type.
- Using over Backlight unit Transflective Type, Transmissive Type

(c) Inspection Environment

Inspection environment it carried out with 250 lx or less in principles.

Product Specification

	Model: GTTV57NN771E0	Rev. No.	Issued Date.	Page.
		A	FEB. 19, 08	20 / 27

7.2 Standards

No.	Parameter	Criteria																																											
1	G Line	Nothing																																											
2	S Line	Nothing																																											
3	Leak	Nothing																																											
4	Bright and Dark Spot	<p>Inspection Criteria Include below with the common inspection. Luminance: under 250 [lx] Distance: 30 ~ 40 [cm] (Perpendicular from panel surface) Time: 5 [S] (After ND filter has been placed)</p> <table border="1" style="width: 100%; border-collapse: collapse; margin-bottom: 10px;"> <thead> <tr> <th style="width: 30%;">Zone</th> <th colspan="2">Acceptable Number</th> </tr> </thead> <tbody> <tr> <td rowspan="3" style="text-align: center;">A</td> <td style="text-align: center;">Bright Spot</td> <td style="text-align: center;">2</td> </tr> <tr> <td style="text-align: center;">Adjacent Dot</td> <td style="text-align: center;">0</td> </tr> <tr> <td style="text-align: center;">Dark Dot</td> <td style="text-align: center;">3</td> </tr> <tr> <td style="text-align: center;">BM</td> <td style="text-align: center;">Bright Spot</td> <td style="text-align: center;">0</td> </tr> </tbody> </table> <p>* Adjacent Dot Horizontal and Vertical Continuous Bright Dots * Bright spot is definition as follows. * Any things that can be seen through 10% transmission ND filter when black signal is inputted.</p>	Zone	Acceptable Number		A	Bright Spot	2	Adjacent Dot	0	Dark Dot	3	BM	Bright Spot	0																														
Zone	Acceptable Number																																												
A	Bright Spot	2																																											
	Adjacent Dot	0																																											
	Dark Dot	3																																											
BM	Bright Spot	0																																											
5	Contrast Variation	Not to be conspicuous defects. Limit sample shall be determined by the arising demand.																																											
6	Black and White Spots, Foreign Material in Polarizer and LR/AR Coat Bright point	<p>(1) Round Shape</p> <table border="1" style="width: 100%; border-collapse: collapse; margin-bottom: 10px;"> <thead> <tr> <th rowspan="2" style="width: 30%;">Zone Dim. (mm)</th> <th colspan="2">Acceptable Number</th> </tr> <tr> <th style="width: 35%;">A</th> <th style="width: 35%;">BM</th> </tr> </thead> <tbody> <tr> <td style="text-align: center;">$D \leq 0.10$</td> <td colspan="2" style="text-align: center;">Disregard</td> </tr> <tr> <td style="text-align: center;">$0.10 < D \leq 0.15$</td> <td colspan="2" style="text-align: center;">4</td> </tr> <tr> <td style="text-align: center;">$0.15 < D \leq 0.20$</td> <td colspan="2" style="text-align: center;">2</td> </tr> <tr> <td style="text-align: center;">$0.20 < D$</td> <td colspan="2" style="text-align: center;">0</td> </tr> </tbody> </table> <p>(2) Line Shape</p> <table border="1" style="width: 100%; border-collapse: collapse; margin-bottom: 10px;"> <thead> <tr> <th rowspan="2" style="width: 15%;">X(mm)</th> <th rowspan="2" style="width: 15%;">Zone Y(mm)</th> <th colspan="2">Acceptable Number</th> </tr> <tr> <th style="width: 35%;">A</th> <th style="width: 35%;">BM</th> </tr> </thead> <tbody> <tr> <td style="text-align: center;">--</td> <td style="text-align: center;">$W \leq 0.01$</td> <td colspan="2" style="text-align: center;">Disregard</td> </tr> <tr> <td style="text-align: center;">$L \leq 2.0$</td> <td style="text-align: center;">$W \leq 0.02$</td> <td colspan="2" style="text-align: center;">2</td> </tr> <tr> <td style="text-align: center;">$L \leq 1.0$</td> <td style="text-align: center;">$W \leq 0.03$</td> <td colspan="2" style="text-align: center;">1</td> </tr> <tr> <td style="text-align: center;">$L > 1.0$</td> <td style="text-align: center;">--</td> <td colspan="2" style="text-align: center;">0</td> </tr> <tr> <td style="text-align: center;">--</td> <td style="text-align: center;">$W > 0.05$</td> <td colspan="2" style="text-align: center;">4</td> </tr> </tbody> </table> <p>X: Length Y: Width</p>	Zone Dim. (mm)	Acceptable Number		A	BM	$D \leq 0.10$	Disregard		$0.10 < D \leq 0.15$	4		$0.15 < D \leq 0.20$	2		$0.20 < D$	0		X(mm)	Zone Y(mm)	Acceptable Number		A	BM	--	$W \leq 0.01$	Disregard		$L \leq 2.0$	$W \leq 0.02$	2		$L \leq 1.0$	$W \leq 0.03$	1		$L > 1.0$	--	0		--	$W > 0.05$	4	
Zone Dim. (mm)	Acceptable Number																																												
	A	BM																																											
$D \leq 0.10$	Disregard																																												
$0.10 < D \leq 0.15$	4																																												
$0.15 < D \leq 0.20$	2																																												
$0.20 < D$	0																																												
X(mm)	Zone Y(mm)	Acceptable Number																																											
		A	BM																																										
--	$W \leq 0.01$	Disregard																																											
$L \leq 2.0$	$W \leq 0.02$	2																																											
$L \leq 1.0$	$W \leq 0.03$	1																																											
$L > 1.0$	--	0																																											
--	$W > 0.05$	4																																											

Product Specification

	Model: GTTV57NN771E0	Rev. No.	Issued Date.	Page.
		A	FEB. 19, 08	21 / 27

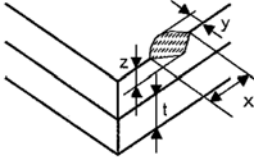
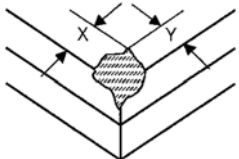
		<p>Total number of this defect (add up round shape and line shape) shall be two or less pieces. Limit sample shall be determined by the arising demand.</p>																	
7	Color Variation	<p>Not to be conspicuous defects. Limit sample shall be determined by the arising demand. However, about the color patches shall be two pieces or less which are same level as the limit sample.</p>																	
8	Air Bubbles (between glass and polarizer)	<table border="1" style="margin-left: auto; margin-right: auto; border-collapse: collapse; text-align: center;"> <thead> <tr> <th rowspan="2">Zone Dim. (mm)</th> <th colspan="2">Acceptable Number</th> </tr> <tr> <th>A</th> <th>BM</th> </tr> </thead> <tbody> <tr> <td>$D \leq 0.10$</td> <td colspan="2">Disregard</td> </tr> <tr> <td>$0.10 < D \leq 0.15$</td> <td colspan="2">1</td> </tr> <tr> <td>$0.15 < D \leq 0.20$</td> <td colspan="2">1</td> </tr> <tr> <td>$0.20 < D$</td> <td colspan="2">0</td> </tr> </tbody> </table> <p>The polarizer edge has not floated. Limit sample shall be determined by the arising demand.</p>	Zone Dim. (mm)	Acceptable Number		A	BM	$D \leq 0.10$	Disregard		$0.10 < D \leq 0.15$	1		$0.15 < D \leq 0.20$	1		$0.20 < D$	0	
Zone Dim. (mm)	Acceptable Number																		
	A	BM																	
$D \leq 0.10$	Disregard																		
$0.10 < D \leq 0.15$	1																		
$0.15 < D \leq 0.20$	1																		
$0.20 < D$	0																		
9	Polarizer Scratches, Stroke Marks	<p>Not to be conspicuous defects. Limit sample shall be determined by the arising demand.</p>																	
10	Polarizer Dirts	<p>If the stains are removed easily from LCDP surface, the module is not defective.</p>																	
11	Chipped glass	<p>(1) Other than electrode pad areas and corner areas</p> <div style="display: flex; align-items: center; justify-content: center;">  <table border="1" style="margin-left: 20px; border-collapse: collapse; text-align: center;"> <thead> <tr> <th>X</th> <th>Y</th> <th>Z</th> </tr> </thead> <tbody> <tr> <td>≤ 5.0</td> <td></td> <td>$\leq 1/2t$</td> </tr> </tbody> </table> </div> <p>(2) Other than electrode pad areas</p> <div style="display: flex; align-items: center; justify-content: center;">  <table border="1" style="margin-left: 20px; border-collapse: collapse; text-align: center;"> <tbody> <tr> <td>$X \leq 1.5 \ \& \ Y \leq 0.5$</td> </tr> <tr> <td>or</td> </tr> <tr> <td>$X \leq 0.5 \ \& \ Y \leq 1.5$</td> </tr> <tr> <td>* The direction of board thickness is disregard</td> </tr> </tbody> </table> </div> <p>* For LCD module holder It is disregard. When it has no problem for appearance, reliability and progressiveness.</p>	X	Y	Z	≤ 5.0		$\leq 1/2t$	$X \leq 1.5 \ \& \ Y \leq 0.5$	or	$X \leq 0.5 \ \& \ Y \leq 1.5$	* The direction of board thickness is disregard							
X	Y	Z																	
≤ 5.0		$\leq 1/2t$																	
$X \leq 1.5 \ \& \ Y \leq 0.5$																			
or																			
$X \leq 0.5 \ \& \ Y \leq 1.5$																			
* The direction of board thickness is disregard																			

Product Specification

	Model: GTTV57NN771E0	Rev. No.	Issued Date.	Page.
		A	FEB. 19, 08	22 / 27

		* For LCD module without holder. The back side is disregard. When it has no problem for reliability and progressiveness. * It is not approved when a glass chip occurs with the part of the seal, wiring and terminal.
--	--	--

7.3 Visual inspection

Should be checked at 22±2°C, 50±5%RH, 300-500 lux, 300mm distance, within 80 degree viewing angle in 4 directions, at typical LED current.

7.3.1 Outside of effective lighting area

Item	Condition	Specification
Particle	Non-Operation	Cannot be shown easily.
Non-lighting, Unstable lighting	Operation	None
Contamination and defects of mold frame	Non-Operation	None

7.3.2 Inside of effective lighting area

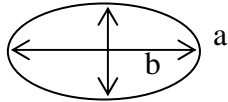
Item	Condition	Specification
Black spot, Particle	Operation	$D < 0.10$: OK (not within 15mm) $0.10 \leq D < 0.20$: 2EA OK (not within 15mm) $D \geq 0.20$: NG $D = (a+b)/2$ <div style="text-align: center;">  </div>
Bright spot, Bright Line, Dim spot Scratch, Newton Ring	Operation	Should not be shown on the glass panel after panel ass'y
Stain	Operation	Should not be shown on the glass panel after panel ass'y

Product Specification

	Model: GTTV57NN771E0	Rev. No.	Issued Date.	Page.
		A	FEB. 19, 08	23 / 27

8 PRECAUTIONS





8.1 Operation

Burn-in sometimes happens when the same character was displayed at along time. Therefore, to prevent Burn-in, it is recommended to set up a Screen-saver function.

8.2 Safety

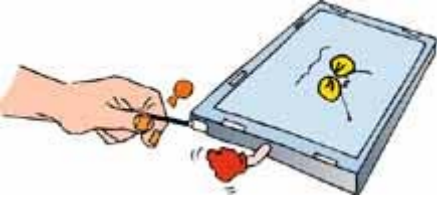



The liquid crystal in the LCD is poisonous, DO NOT put it in your mouth. If the liquid crystal touches your skin or clothes, wash it off immediately using soap and water.

8.3 Handling

	<p>a. The LCD module shall be installed flat, without twisting or bending.</p> <p>b. COF or FPC has narrow pattern width, so easily become open circuit by external force. DO NOT apply pressure to COF or FPC especially in bending area.</p>
	<p>c. To avoid damage in appearance or malfunction, DO NOT subject the module to mechanical shock or to excessive force on its surface.</p>
	<p>d. The polarizer attached to the display is very easy to damage, handle it with care to avoid scratching.</p>
	<p>e. To avoid contamination on the display surface, DO NOT touch the display surface with bare hands.</p> <p>f. Provide a space so that the LCD module does not come into contact with other components.</p>
	<p>g. To protect the LCD panel from external pressure, put covering glass (acrylic board or similar board) to keep appropriate space between them.</p>

Product Specification

	Model: GTTV57NN771E0	Rev. No.	Issued Date.	Page.
		A	FEB. 19, 08	24 / 27

	<p>h. Be careful for condensation at sudden temperature change. Condensation makes damage to polarizer or electrical contacted parts. And after fading condensation, smear or spot will occur.</p>
	<p>i. Property of semiconductor devices may be affected when they are exposed to light possibly resulting in malfunctioning of the ICs. To prevent such malfunctioning of the ICs, your design and mounting layout done are so that the IC is not exposed to light in actual use.</p>
	<p>j. Strong light exposure causes degradation of color filter. It may not recover</p>
	<p>k. DO NOT contact with water to avoid Metal corrosion. l. When it is not in use, the screen must be turned off or the pattern must be frequently changed by a screen saver. If it displays the same pattern for a long period of time, brightness down/image sticking may develop due to the LCD structure.</p>
	<p>m. Never disassemble LCD product under any circumstances. If unqualified operators or users assemble the product after disassembling it, it may not function or its operation may be seriously affected.</p>

Product Specification

	Model: GTTV57NN771E0	Rev. No.	Issued Date.	Page.
		A	FEB. 19, 08	25 / 27

8.4 Static electricity

Since a module is composed of electronic circuits, it is not strong to electrostatic discharge.

	<ol style="list-style-type: none">The LCD module shall be installed flat, without twisting or bending. Ground soldering iron tips, tools and testers when they operate.Ground your body when handling the products.DO NOT apply voltage to the input terminal without applying power supply.DO NOT apply voltage that exceeds the absolute maximum rating.Store the products in an anti-electrostatic container.Peel off protect tape, attached to polarizer, slowly to minimize ESD damage.
---	---

8.5 Storage

	<p>Store the products in a dark place at +5 ~ +25 degree C, low humidity (50%RH or less).</p> <p>DO NOT store the products in an atmosphere containing organic solvents or corrosive gases.</p>
---	---

8.6 Cleaning

	<ol style="list-style-type: none">DO NOT wipe the polarizer with dry cloth, as it might cause scratch.Wipe the polarizer with a soft cloth soaked with petroleum IPA, other chemical might damage.
---	---

8.7 Waste

	<p>When dispose of LCD module, manage it at the production waste according to the relevant laws and regulations.</p>
---	--

Product Specification				
	Model: GTTV57NN771E0	Rev. No.	Issued Date.	Page.
		A	FEB. 19, 08	26 / 27

9 WARRANTY

This product has been manufactured to your company’s specifications as a part for use in your company’s general electronic products. It is guaranteed to perform according to delivery specifications. For any other use apart from general electronic equipment, we cannot take responsibility if the product is used in medical devices, nuclear power control equipment, aerospace equipment, fire and security systems, or any other applications in which there is a direct risk to human life and where extremely high levels of reliability are required. If the product is to be used in any of the above applications, we will need to enter into a separate product liability agreement.

- 1 We cannot accept responsibility for any defect, which may arise from additional manufacturing of the product (including disassembly and reassembly), after product delivery.
- 2 We cannot accept responsibility for any defect, which may arise after the application of strong external force to the product.
- 3 We cannot accept responsibility for any defect, which may arise due to the application of static electricity after the product has passed your company’s acceptance inspection procedures.
- 4 We cannot accept responsibility for industrial property, which may arise through the use of your product, with exception to those issues relating directly to the structure or method of manufacturing of our product. SGD-origin longer than one year from SGD production.

